



Our commitment is **your safe future**

Electrical Installations from A to Z
Price List w.e.f. 15th October, 2023

SIEMENS



The safe choice –
now made smarter

SENTRON circuit protection devices with
communication and measuring function

[siemens.com/circuit-protection](https://www.siemens.com/circuit-protection)

SIEMENS



Sr. No.	Items	Pg. No.
1	Betagard Miniature Circuit Breakers	
	5SL6, 7.5kA with C characteristics	5
	5SL6, 7.5kA with B characteristics	6
	5SL4, 10kA with C characteristics	7
	5SL7, with C characteristics	8
2	Betagard Circuit Breakers	
	5SL7, with K characteristics	11
	5SL4, with Z characteristics	12
	5SY4, 10kA CBs with C characteristics	13
3	Betagard Isolators	
	5TL1 Isolators	14
4	Betagard DC Circuit Breakers	
	5SL5, 10kA DC with C characteristics	14
5	Betagard Residual Current Circuit Breakers	
	5SV RCCB - Type AC, Type A	18
6	SENTRON Residual Current Units <small>NEW</small>	
	5SM2..RC, RC Units- Type AC, Type A	20
	Accessories selection - Remote control mechanism	21
7	Betagard Residual Current Breaker Operators	
	5SU1 RCBO, 10kA, Type AC with C and D characteristics	22
8	Betagard Accessories	24
	SINOVA Opulenz	25
9	Arc Fault Detection Devices (AFDD)	26-27
10	SENTRON COM Devices <small>NEW</small>	28-29
	5SV6 AFDD COM	30
	7KN Powercenter 1000	30
11	SINOVA STR4 ACCL	31
12	Betagard Distribution Boards	
	8GB32 SPN, TPN & Phase Segregated DBs	33-35
	Industrial Plug & Socket DBs, Simbox WP DBs	36
	Accessories for Betagard DBs	37
13	SINOVA Low Voltage Switchgears	38
14	SENTRON Surge Protection Devices	
	Surge Protection Devices	40-42
15	SENTRON Modular Devices	
	Changeover switches, Insta contactors	44
	Twilight switch, Voltage relays, Indicators and Fuse monitors	45
	Time switches	46
16	SINOVA MCCBs - 3VJ, RAJA+ Starters	47-49
	ordering info	
17	Switch Disconnecter Fuses - 3KL and Fuses - 3NA/3NW	50
	ordering info	
18	Available till stocks last	51-52
19	Discontinued products	53
20	Multi channel current measuring system	54-55
21	Technical Information	56-57
22	Customer Care	58

Betagard 5SL MCBs – Inspiring Safety

Terminal covers for protection

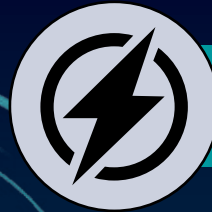

High Breaking capacity (Icn)

High Endurance Cycle

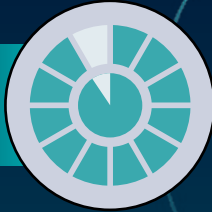

Very low watt loss

Ergonomic Handle for Identification

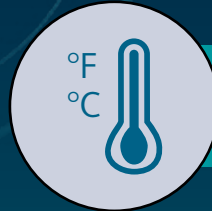

High ambient temperature

RoHS Compliant

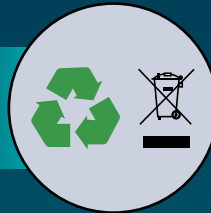

With SLR

Unique SLR (Slide Latch-Release) feature for tool free removal from DIN rail allows individual MCB to be removed from bus bar mounted assembly without disturbing other devices





BIS approval for ISI marking as per latest IS/IEC 60898-1:2015 for assured quality and protection



Unique termination mechanism enables firm mounting of Bus bar together with wire; and provides front access to wires for safe installation

Betagard Miniature Circuit Breakers 5SL6, with C Characteristics

- Standards: IS/IEC 60898-1:2015
- Voltage: Un 240/415V, 50...60Hz[^]
- With ISI marking: CM/L No. 2255548

7500A	Rated Current I_n (A)	MW#	Reference No	Unit MRP* ₹	Std. Pkg.** (Nos.)
1P, 240/415V AC 	0.5	1	5SL61057RC	523.-	1/12
	1		5SL61017RC	523.-	1/12
	2		5SL61027RC	523.-	1/12
	3		5SL61037RC	523.-	1/12
	4		5SL61047RC	523.-	1/12
	6		5SL61067RC	324.-	1/12
	8		5SL61087RC	324.-	1/12
	10		5SL61107RC	324.-	1/12
	13		5SL61137RC	324.-	1/12
	16		5SL61167RC	324.-	1/12
	20		5SL61207RC	324.-	1/12
	25		5SL61257RC	324.-	1/12
	32		5SL61327RC	324.-	1/12
	40		5SL61407RC	714.-	1/12
	50		5SL61507RC	821.-	1/12
63	5SL61637RC	821.-	1/12		
2P, 415V AC 	0.5	2	5SL62057RC	1464.-	1/6
	1		5SL62017RC	1464.-	1/6
	2		5SL62027RC	1464.-	1/6
	3		5SL62037RC	1464.-	1/6
	4		5SL62047RC	1464.-	1/6
	6		5SL62067RC	1096.-	1/6
	8		5SL62087RC	1096.-	1/6
	10		5SL62107RC	1096.-	1/6
	13		5SL62137RC	1096.-	1/6
	16		5SL62167RC	1096.-	1/6
	20		5SL62207RC	1096.-	1/6
	25		5SL62257RC	1096.-	1/6
	32		5SL62327RC	1096.-	1/6
	40		5SL62407RC	1538.-	1/6
	50		5SL62507RC	1806.-	1/6
63	5SL62637RC	1806.-	1/6		
3P, 415V AC 	0.5	3	5SL63057RC	2056.-	1/4
	1		5SL63017RC	2056.-	1/4
	2		5SL63027RC	2056.-	1/4
	4		5SL63047RC	2056.-	1/4
	6		5SL63067RC	1646.-	1/4
	10		5SL63107RC	1646.-	1/4
	16		5SL63167RC	1646.-	1/4
	20		5SL63207RC	1646.-	1/4
	25		5SL63257RC	1646.-	1/4
	32		5SL63327RC	1646.-	1/4
	40		5SL63407RC	2304.-	1/4
	50		5SL63507RC	2573.-	1/4
	63		5SL63637RC	2573.-	1/4
4P, 415V AC 	0.5	4	5SL64057RC	2838.-	1/3
	1		5SL64017RC	2838.-	1/3
	2		5SL64027RC	2838.-	1/3
	4		5SL64047RC	2838.-	1/3
	6		5SL64067RC	2276.-	1/3
	10		5SL64107RC	2276.-	1/3
	16		5SL64167RC	2276.-	1/3
	20		5SL64207RC	2276.-	1/3
	25		5SL64257RC	2276.-	1/3
	32		5SL64327RC	2276.-	1/3
	40		5SL64407RC	2941.-	1/3
	50		5SL64507RC	3405.-	1/3
	63		5SL64637RC	3405.-	1/3

■ Stock items

Note:

* MRP - Maximum Retail Price

1MW (Module Width) = 18mm





** Purchase MOQ for our authorized dealers is in multiples of standard packing, contact Siemens Sales Office for further details

^ Suitable for DC networks in Telecom application; 60V DC for 1P & 110V DC for 2P (contact sales office for connection diagram)

Betagard Miniature Circuit Breakers 5SL6, with B Characteristics



- Standards: IS/IEC 60898-1:2015
- Voltage: Un 240/415V, 50...60Hz
- With ISI marking: CM/L No. 2255548

7500A	Rated Current I_n (A)	MW#	Reference No	Unit MRP* ₹	Std. Pkg.** (Nos.)
1P, 240/415V AC 	6	1	5SL61066RC	318.-	1/12
	10		5SL61106RC	318.-	1/12
	16		5SL61166RC	318.-	1/12
	20		5SL61206RC	318.-	1/12
	25		5SL61256RC	318.-	1/12
	32		5SL61326RC	318.-	1/12
	40		5SL61406RC	710.-	1/12
	50		5SL61506RC	798.-	1/12
	63		5SL61636RC	798.-	1/12
	2P, 415V AC 		6	2	5SL62066RC
10		5SL62106RC	1084.-		1/6
16		5SL62166RC	1084.-		1/6
20		5SL62206RC	1084.-		1/6
25		5SL62256RC	1084.-		1/6
32		5SL62326RC	1084.-		1/6
40		5SL62406RC	1524.-		1/6
50		5SL62506RC	1791.-		1/6
63		5SL62636RC	1791.-		1/6
3P, 415V AC 		6	3		5SL63066RC
	10	5SL63106RC		1646.-	1/4
	16	5SL63166RC		1646.-	1/4
	20	5SL63206RC		1646.-	1/4
	25	5SL63256RC		1646.-	1/4
	32	5SL63326RC		1646.-	1/4
	40	5SL63406RC		2274.-	1/4
	50	5SL63506RC		2550.-	1/4
	63	5SL63636RC		2550.-	1/4
	4P, 415V AC 	6		4	5SL64066RC
10		5SL64106RC	2263.-		1/3
16		5SL64166RC	2263.-		1/3
20		5SL64206RC	2263.-		1/3
25		5SL64256RC	2263.-		1/3
32		5SL64326RC	2263.-		1/3
40		5SL64406RC	2825.-		1/3
50		5SL64506RC	3395.-		1/3
63		5SL64636RC	3395.-		1/3

■ Stock items

Note:

* MRP - Maximum Retail Price # 1MW (Module Width) = 18mm

** Purchase MOQ for our authorized dealers is in multiples of standard packing, contact Siemens Sales Office for further details







Betagard Miniature Circuit Breakers 5SL4, with C characteristics

IS/IEC 60898 - 1



CM/L No. 2255548

- Standards: IS/IEC 60898-1:2015
- Voltage: Un 240/415V, 50...60Hz[^]
- Breaking capacity: 10kA as per IS/IEC 60898-1
- With ISI marking: CM/L No. 2255548

10000A	Rated Current I _n (A)	MW#	Reference No	Unit MRP* ₹	Std. Pkg.** (Nos.)
	1P, 240/415V AC	1	5SL41057RC	590.-	1/12
	0.5	1	5SL41027RC	590.-	1/12
	2	1	5SL41037RC	590.-	1/12
	3	1	5SL41047RC	590.-	1/12
	4	1	5SL41067RC	382.-	1/12
	6	1	5SL41087RC	382.-	1/12
	8	1	5SL41107RC	382.-	1/12
	10	1	5SL41137RC	382.-	1/12
	13	1	5SL41167RC	382.-	1/12
	16	1	5SL41207RC	382.-	1/12
	20	1	5SL41257RC	382.-	1/12
	25	1	5SL41327RC	382.-	1/12
	32	1	5SL41407RC	832.-	1/12
	40	1	5SL41507RC	857.-	1/12
50	1	5SL41637RC	857.-	1/12	
63	1	5SL41637RC	857.-	1/12	
	2P, 415V AC	2	5SL42057RC	1656.-	1/6
	0.5	2	5SL42027RC	1656.-	1/6
	2	2	5SL42037RC	1656.-	1/6
	3	2	5SL42047RC	1656.-	1/6
	4	2	5SL42067RC	1187.-	1/6
	6	2	5SL42087RC	1187.-	1/6
	8	2	5SL42107RC	1187.-	1/6
	10	2	5SL42137RC	1187.-	1/6
	13	2	5SL42167RC	1187.-	1/6
	16	2	5SL42207RC	1187.-	1/6
	20	2	5SL42257RC	1187.-	1/6
	25	2	5SL42327RC	1187.-	1/6
	32	2	5SL42407RC	1914.-	1/6
	40	2	5SL42507RC	1914.-	1/6
50	2	5SL42637RC	1914.-	1/6	
63	2	5SL42637RC	1914.-	1/6	
	3P, 415V AC	3	5SL43057RC	2675.-	1/4
	0.5	3	5SL43027RC	2675.-	1/4
	2	3	5SL43037RC	2675.-	1/4
	3	3	5SL43047RC	2675.-	1/4
	4	3	5SL43067RC	1993.-	1/4
	6	3	5SL43087RC	1993.-	1/4
	8	3	5SL43107RC	1993.-	1/4
	10	3	5SL43137RC	1993.-	1/4
	13	3	5SL43167RC	1993.-	1/4
	16	3	5SL43207RC	1993.-	1/4
	20	3	5SL43257RC	1993.-	1/4
	25	3	5SL43327RC	1993.-	1/4
	32	3	5SL43407RC	3016.-	1/4
	40	3	5SL43507RC	3016.-	1/4
50	3	5SL43637RC	3016.-	1/4	
63	3	5SL43637RC	3016.-	1/4	
	4P, 415V AC	4	5SL44057RC	3362.-	1/3
	0.5	4	5SL44027RC	3362.-	1/3
	2	4	5SL44037RC	3362.-	1/3
	3	4	5SL44047RC	3362.-	1/3
	4	4	5SL44067RC	2759.-	1/3
	6	4	5SL44087RC	2759.-	1/3
	8	4	5SL44107RC	2759.-	1/3
	10	4	5SL44137RC	2759.-	1/3
	13	4	5SL44167RC	2759.-	1/3
	16	4	5SL44207RC	2759.-	1/3
	20	4	5SL44257RC	2759.-	1/3
	25	4	5SL44327RC	2759.-	1/3
	32	4	5SL44407RC	3764.-	1/3
	40	4	5SL44507RC	3764.-	1/3
50	4	5SL44637RC	3764.-	1/3	
63	4	5SL44637RC	3764.-	1/3	

■ Stock items

Note: * MRP - Maximum Retail Price # 1MW (Module Width) = 18mm





** Purchase MOQ for our authorized dealers is in multiples of standard packing, contact Siemens Sales Office for further details

^ Suitable for DC networks in Telecom application; 60V DC for 1P & 110V DC for 2P (contact sales office for connection diagram)

Betagard Miniature Circuit Breakers 5SL7, with C characteristics



- Standards: IS/IEC 60898-1:2015
- Voltage: Un 240/415V, 50....60Hz
- Breaking capacity: 15kA¹⁾ as per IS/IEC 60898-1
- With ISI marking: CM/L No. 2255548

	Rated Current I_n (A)	MW#	Reference No	Unit MRP* ₹	Std. Pkg.** (Nos.)
	0.5	1	5SL71057RC	660.-	1/12
	1		5SL71017RC	660.-	1/12
	2		5SL71027RC	650.-	1/12
	4		5SL71047RC	650.-	1/12
	6		5SL71067RC	562.-	1/12
	10		5SL71107RC	562.-	1/12
	16		5SL71167RC	562.-	1/12
	20		5SL71207RC	562.-	1/12
	25		5SL71257RC	562.-	1/12
	32		5SL71327RC	562.-	1/12
	40		5SL71407RC	879.-	1/12
	50		5SL71507RC	889.-	1/12
	63		5SL71637RC	889.-	1/12
	0.5	2	5SL72057RC	1862.-	1/6
	1		5SL72017RC	1862.-	1/6
	2		5SL72027RC	1830.-	1/6
	4		5SL72047RC	1830.-	1/6
	6		5SL72067RC	1331.-	1/6
	10		5SL72107RC	1331.-	1/6
	16		5SL72167RC	1331.-	1/6
	20		5SL72207RC	1331.-	1/6
	25		5SL72257RC	1331.-	1/6
	32		5SL72327RC	1331.-	1/6
	40		5SL72407RC	2007.-	1/6
	50		5SL72507RC	2007.-	1/6
	63		5SL72637RC	2007.-	1/6
	0.5	3	5SL73057RC	2860.-	1/4
	1		5SL73017RC	2860.-	1/4
	2		5SL73027RC	2808.-	1/4
	4		5SL73047RC	2808.-	1/4
	6		5SL73067RC	2116.-	1/4
	10		5SL73107RC	2116.-	1/4
	16		5SL73167RC	2116.-	1/4
	20		5SL73207RC	2116.-	1/4
	25		5SL73257RC	2116.-	1/4
	32		5SL73327RC	2116.-	1/4
	40		5SL73407RC	3156.-	1/4
	50		5SL73507RC	3156.-	1/4
	63		5SL73637RC	3156.-	1/4
	0.5	4	5SL74057RC	3604.-	1/3
	1		5SL74017RC	3604.-	1/3
	2		5SL74027RC	3536.-	1/3
	4		5SL74047RC	3536.-	1/3
	6		5SL74067RC	2834.-	1/3
	10		5SL74107RC	2834.-	1/3
	16		5SL74167RC	2834.-	1/3
	20		5SL74207RC	2834.-	1/3
	25		5SL74257RC	2834.-	1/3
	32		5SL74327RC	2834.-	1/3
	40		5SL74407RC	3973.-	1/3
	50		5SL74507RC	3973.-	1/3
	63		5SL74637RC	3973.-	1/3

Note:





* MRP - Maximum Retail Price # 1MW (Module Width) = 18mm

** Purchase MOQ for our authorized dealers is in multiples of standard packing, contact Siemens Sales Office for further details

¹⁾ Breaking capacity 63A - 10kA

Betagard Miniature Circuit Breakers 5SL7, with D characteristics

- Standards: IS/IEC 60898-1
- Voltage: Un 240/415V, 50....60Hz
- Breaking capacity: 15kA¹⁾ as per IS/IEC 60898-1
- With ISI marking: CM/L No. 2255548

	Rated Current I_n (A)	MW#	Reference No	Unit MRP* ₹	Std. Pkg.** (Nos.)
1P, 240/415V AC 	0.5	1	5SL71058RC	671.-	1/12
	1		5SL71018RC	671.-	1/12
	2		5SL71028RC	650.-	1/12
	4		5SL71048RC	650.-	1/12
	6		5SL71068RC	582.-	1/12
	10		5SL71108RC	582.-	1/12
	16		5SL71168RC	582.-	1/12
	20		5SL71208RC	582.-	1/12
	25		5SL71258RC	582.-	1/12
	32		5SL71328RC	582.-	1/12
	40		5SL71408RC	1134.-	1/12
	50		5SL71508RC	1134.-	1/12
	63		5SL71638RC	1134.-	1/12
2P, 415V AC 	0.5	2	5SL72058RC	1898.-	1/6
	1		5SL72018RC	1898.-	1/6
	2		5SL72028RC	1830.-	1/6
	4		5SL72048RC	1830.-	1/6
	6		5SL72068RC	1404.-	1/6
	10		5SL72108RC	1404.-	1/6
	16		5SL72168RC	1404.-	1/6
	20		5SL72208RC	1404.-	1/6
	25		5SL72258RC	1404.-	1/6
	32		5SL72328RC	1404.-	1/6
	40		5SL72408RC	2590.-	1/6
	50		5SL72508RC	2590.-	1/6
	63		5SL72638RC	2590.-	1/6
3P, 415V AC 	0.5	3	5SL73058RC	2917.-	1/4
	1		5SL73018RC	2917.-	1/4
	2		5SL73028RC	2808.-	1/4
	4		5SL73048RC	2808.-	1/4
	6		5SL73068RC	2226.-	1/4
	10		5SL73108RC	2226.-	1/4
	16		5SL73168RC	2226.-	1/4
	20		5SL73208RC	2226.-	1/4
	25		5SL73258RC	2226.-	1/4
	32		5SL73328RC	2226.-	1/4
	40		5SL73408RC	4040.-	1/4
	50		5SL73508RC	4040.-	1/4
	63		5SL73638RC	4040.-	1/4
4P, 415V AC 	0.5	4	5SL74058RC	3728.-	1/3
	1		5SL74018RC	3728.-	1/3
	2		5SL74028RC	3593.-	1/3
	4		5SL74048RC	3593.-	1/3
	6		5SL74068RC	2943.-	1/3
	10		5SL74108RC	2943.-	1/3
	16		5SL74168RC	2943.-	1/3
	20		5SL74208RC	2943.-	1/3
	25		5SL74258RC	2943.-	1/3
	32		5SL74328RC	2943.-	1/3
	40		5SL74408RC	5075.-	1/3
	50		5SL74508RC	5075.-	1/3
	63		5SL74638RC	5075.-	1/3

Note:

* MRP - Maximum Retail Price # 1MW (Module Width) = 18mm

** Purchase MOQ for our authorized dealers is in multiples of standard packing, contact Siemens Sales Office for further details

¹⁾ Breaking capacity 40A - 63A: 10kA

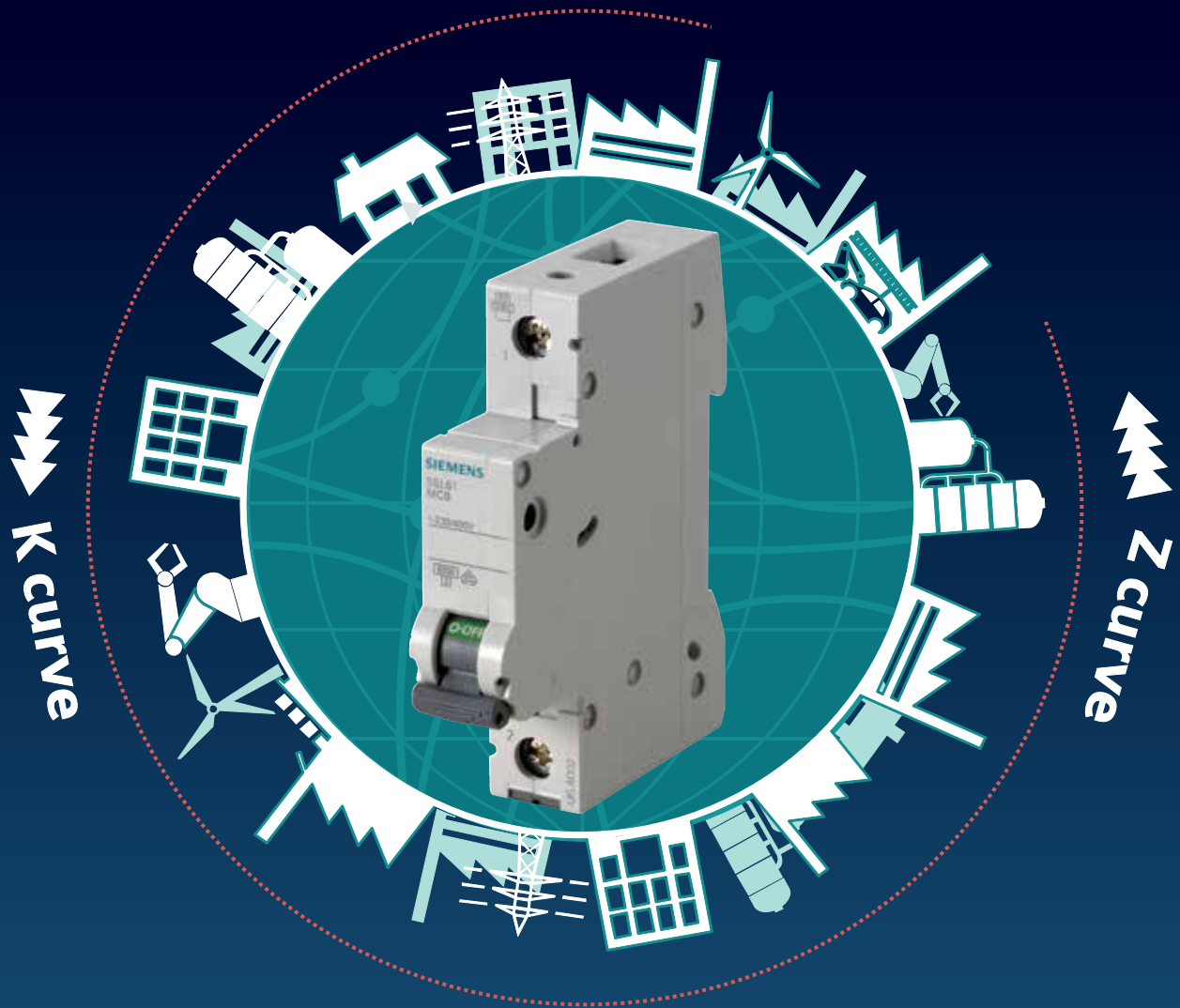

5SL Circuit Breaker - K & Z Curve

"K" Characteristic Trip Curve:

MCB trips instantaneously when the current flowing through it reaches between 10 to 14 times the rated current.

Suitable for inductive and motor loads with high inrush currents; etc

"Z" Characteristic Trip Curve:

MCB trips when the current flowing through it reaches between 2 to 3 times the rated current, highly sensitive to short circuit current

Suitable for the protection of highly sensitive devices such as semiconductor devices,





- In compliance with standards IEC 60947-2
- Range available from 2A – 63A
- Comprehensive features & accessories in line with 5SL MCB
- For protection in Industrial, Infrastructure, Process Automation, Commercial applications

www.siemens.co.in

SIEMENS

Betagard Circuit Breakers 5SL7, with K characteristics

- Standards: IS/IEC 60947-2
- Voltage: Un 240/415V, 50....60Hz
- Breaking capacity: 15kA¹⁾ as per IS/IEC 60947-2

	Rated Current I_n (A)	MW#	Reference No	Unit MRP* ₹	Std. Pkg.** (Nos.)
1P, 240/415V AC 	2	1	5SL71023RC	582.-	1/12
	4		5SL71043RC	582.-	1/12
	6		5SL71063RC	520.-	1/12
	10		5SL71103RC	515.-	1/12
	16		5SL71163RC	520.-	1/12
	20		5SL71203RC	515.-	1/12
	25		5SL71253RC	520.-	1/12
	32		5SL71323RC	520.-	1/12
	40		5SL71403RC	915.-	1/12
	63		5SL71633RC	1071.-	1/12
2P, 415V AC 	2	2	5SL72023RC	1752.-	1/6
	4		5SL72043RC	1752.-	1/6
	6		5SL72063RC	1622.-	1/6
	10		5SL72103RC	1591.-	1/6
	16		5SL72163RC	1622.-	1/6
	20		5SL72203RC	1591.-	1/6
	25		5SL72253RC	1622.-	1/6
	32		5SL72323RC	1622.-	1/6
	40		5SL72403RC	1960.-	1/6
	63		5SL72633RC	2257.-	1/6
3P, 415V AC 	2	3	5SL73023RC	2720.-	1/4
	4		5SL73043RC	2720.-	1/4
	6		5SL73063RC	2491.-	1/4
	10		5SL73103RC	2439.-	1/4
	16		5SL73163RC	2491.-	1/4
	20		5SL73203RC	2439.-	1/4
	25		5SL73253RC	2491.-	1/4
	32		5SL73323RC	2491.-	1/4
	40		5SL73403RC	2772.-	1/4
	63		5SL73633RC	3115.-	1/4
4P, 415V AC 	2	4	5SL74023RC	3474.-	1/3
	4		5SL74043RC	3474.-	1/3
	6		5SL74063RC	3276.-	1/3
	10		5SL74103RC	3214.-	1/3
	16		5SL74163RC	3276.-	1/3
	20		5SL74203RC	3214.-	1/3
	25		5SL74253RC	3276.-	1/3
	32		5SL74323RC	3276.-	1/3
	40		5SL74403RC	3578.-	1/3
	63		5SL74633RC	4030.-	1/3

Note:





* MRP - Maximum Retail Price # 1MW (Module Width) = 18mm

** Purchase MOQ for our authorized dealers is in multiples of standard packing, contact Siemens Sales Office for further details

¹⁾ Breaking capacity 40A - 63A: 10kA

Betagard Circuit Breakers 5SL4, with Z characteristics

- Standards: IS/IEC 60947-2
- Voltage: Un 240/415V, 50....60Hz
- Breaking capacity: 10kA as per IS/IEC 60947-2

	Rated Current I_n (A)	MW#	Reference No	Unit MRP* ₹	Std. Pkg.** (Nos.)
1P, 240/415V AC 	2	1	5SL41020RC	795.-	1/12
	4		5SL41040RC	795.-	1/12
	6		5SL41060RC	625.-	1/12
	10		5SL41100RC	625.-	1/12
	16		5SL41160RC	625.-	1/12
	20		5SL41200RC	625.-	1/12
	25		5SL41250RC	625.-	1/12
	32		5SL41320RC	625.-	1/12
	40		5SL41400RC	824.-	1/12
	63		5SL41630RC	824.-	1/12
2P, 415V AC 	2	2	5SL42020RC	1505.-	1/6
	4		5SL42040RC	1505.-	1/6
	6		5SL42060RC	1420.-	1/6
	10		5SL42100RC	1420.-	1/6
	16		5SL42160RC	1420.-	1/6
	20		5SL42200RC	1420.-	1/6
	25		5SL42250RC	1420.-	1/6
	32		5SL42320RC	1420.-	1/6
	40		5SL42400RC	1646.-	1/6
	63		5SL42630RC	1646.-	1/6
3P, 415V AC 	2	3	5SL43020RC	2385.-	1/4
	4		5SL43040RC	2385.-	1/4
	6		5SL43060RC	1987.-	1/4
	10		5SL43100RC	1987.-	1/4
	16		5SL43160RC	1987.-	1/4
	20		5SL43200RC	1987.-	1/4
	25		5SL43250RC	1987.-	1/4
	32		5SL43320RC	1987.-	1/4
	40		5SL43400RC	2498.-	1/4
	63		5SL43630RC	2498.-	1/4
4P, 415V AC 	2	4	5SL44020RC	2583.-	1/3
	4		5SL44040RC	2583.-	1/3
	6		5SL44060RC	2243.-	1/3
	10		5SL44100RC	2243.-	1/3
	16		5SL44160RC	2243.-	1/3
	20		5SL44200RC	2243.-	1/3
	25		5SL44250RC	2243.-	1/3
	32		5SL44320RC	2243.-	1/3
	40		5SL44400RC	2816.-	1/3
	63		5SL44630RC	2816.-	1/3

Note:

* MRP - Maximum Retail Price # 1MW (Module Width) = 18mm

** Purchase MOQ for our authorized dealers is in multiples of standard packing, contact Siemens Sales Office for further details

Betagard Circuit Breakers 5SY4, with C characteristics

- Standards: IEC/EN 60947-2
- Voltage: Un 230/400V
- Breaking capacity: 10kA as per IEC/EN 60947-2

C characteristic

10000A		Rated Current I _n (A)	MW#	Reference No	Unit MRP* ₹	Std. Pkg.** (Nos.)
	1Pole	80A	1	5SY41807CC	4599.-	1/1
	2Pole		2	5SY42807CC	9043.-	1/1
	3Pole		3	5SY43807CC	14111.-	1/1
	4Pole		4	5SY44807CC	20219.-	1/1



Betagard Miniature Circuit Breakers 5SP4, with C/D characteristics

IS/IEC 60898 - 1





- Standards: IS/IEC 60898-1:2002
- Voltage: Un 240/415V
- Breaking capacity: 10kA as per IS/IEC 60898-1:2002
- With ISI marking: CM/L No. 2255548

C characteristic

10000A		Rated Current I _n (A)	MW#	Reference No	Unit MRP* ₹	Std. Pkg.** (Nos.)
	1-pole	80	1.5	5SP41807RC	4043.-	1/10
		100		5SP41917RC	4264.-	1/10
		125		5SP41927RC	4841.-	1/10
	2-pole	80	3	5SP42807RC	7941.-	1/5
		100		5SP42917RC	8369.-	1/5
		125		5SP42927RC	9471.-	1/5
	3-pole	80	4.5	5SP43807RC	12396.-	1/1
		100		5SP43917RC	12721.-	1/1
		125		5SP43927RC	14580.-	1/1
	4-pole	80	6	5SP44807RC	17778.-	1/1
		100		5SP44917RC	18293.-	1/1
		125		5SP44927RC	20827.-	1/1

D characteristic

	1-pole	80	1.5	5SP41808RC	4455.-	1/10
		100		5SP41918RC	4671.-	1/10
	2-pole	80	3	5SP42808RC	8940.-	1/5
		100		5SP42918RC	9476.-	1/5
	3-pole	80	4.5	5SP43808RC	13771.-	1/1
		100		5SP43918RC	13910.-	1/1
	4-pole	80	6	5SP44808RC	19369.-	1/1
		100		5SP44918RC	19864.-	1/1

Note:



* MRP - Maximum Retail Price

1MW (Module Width) = 18mm

** Purchase MOQ for our authorized dealers is in multiples of standard packing, contact Siemens Sales Office for further details

Betagard Circuit Breakers 5SL5, DC with C Characteristics

- Standards: IS/IEC 60947-2
- Voltage: 220V DC/1P & 440V DC/2P^
- Breaking capacity: 10kA as per IS/IEC 60947-2

10000A	Rated Current I_n (A)	MW#	Reference No	Unit MRP* ₹	Std. Pkg.** (Nos.)
	1P, 220V DC	1	5SL51057RC	979.-	1/12
	0.5	1	5SL51017RC	979.-	1/12
	1	1	5SL51027RC	1051.-	1/12
	2	1	5SL51037RC	1107.-	1/12
	3	1	5SL51047RC	1051.-	1/12
	4	1	5SL51067RC	896.-	1/12
	6	1	5SL51087RC	948.-	1/12
	8	1	5SL51107RC	896.-	1/12
	10	1	5SL51167RC	896.-	1/12
	16	1	5SL51207RC	896.-	1/12
	20	1	5SL51257RC	896.-	1/12
	25	1	5SL51327RC	896.-	1/12
	32	1	5SL51407RC	1339.-	1/12
	40	1	5SL51507RC	1339.-	1/12
	50	1	5SL51637RC	1339.-	1/12
63	1				
	2P, 440V DC	2	5SL52057RC	2132.-	1/6
	0.5	2	5SL52017RC	2132.-	1/6
	1	2	5SL52027RC	2132.-	1/6
	2	2	5SL52037RC	2230.-	1/6
	3	2	5SL52047RC	2132.-	1/6
	4	2	5SL52067RC	1864.-	1/6
	6	2	5SL52087RC	1957.-	1/6
	8	2	5SL52107RC	1864.-	1/6
	10	2	5SL52167RC	1864.-	1/6
	16	2	5SL52207RC	1864.-	1/6
	20	2	5SL52257RC	1864.-	1/6
	25	2	5SL52327RC	1864.-	1/6
	32	2	5SL52407RC	2760.-	1/6
	40	2	5SL52507RC	2760.-	1/6
	50	2	5SL52637RC	2760.-	1/6
63	2				



■ Stock items

^ For connection diagram, contact Siemens Sales Office for further details.

• Also available DC Circuit Breakers for Solar applications - contact Siemens sales office for further details.

Betagard Isolators 5TL1

- Standard: IS/IEC 60947-3
- Voltage: 440V AC

	Rated Current I_n (A)	MW#	Reference No	Unit MRP* ₹	Std. Pkg.** (Nos.)
	2-pole	2	5TL12400	900.-	1/1
	40	2	5TL12630	1185.-	1/1
	63	2	5TL12800	1550.-	1/1
	80	2	5TL12910	1970.-	1/1
	100	2	5TL12920	2055.-	1/1
	3-pole	3	5TL13400	1675.-	1/1
	40	3	5TL13630	1875.-	1/1
	63	3	5TL13800	2270.-	1/1
	80	3	5TL13910	2385.-	1/1
	100	3	5TL13920	2575.-	1/1
	4-pole	4	5TL14400	1960.-	1/1
	40	4	5TL14630	2235.-	1/1
	63	4	5TL14800	2690.-	1/1
	80	4	5TL14910	3230.-	1/1
	100	4	5TL14920	3500.-	1/1

Note:

* MRP - Maximum Retail Price # 1MW (Module Width) = 18mm

** Purchase MOQ for our authorized dealers is in multiples of standard packing, contact Siemens Sales Office for further details

Betagard Circuit Breakers 5SL5, 4-pole DC with C Characteristics

- Standards: IS/IEC 60947-2
- Voltage: 880V DC/4P[^]
- Breaking capacity: 10kA as per IS/IEC 60947-2

10000A	Rated Current I_n (A)	MW#	Reference No	Unit MRP* ₹	Std. Pkg.** (Nos.)
	4P, 880V DC ¹⁾	4	5SL54067RC	3770.-	1/3
	6		5SL54107RC	3770.-	1/3
	10		5SL54167RC	3770.-	1/3
	16		5SL54257RC	4012.-	1/3
	25		5SL54327RC	4012.-	1/3
	32		5SL54407RC	4717.-	1/3
	40		5SL54637RC	4949.-	1/3
63					

1) Maximum operational voltage 1000V DC

[^] For connection diagram, contact Siemens Sales Office for further details.

Note:

* MRP - Maximum Retail Price # 1MW (Module Width) = 18mm

** Purchase MOQ for our authorized dealers is in multiples of standard packing, contact Siemens Sales Office for further details



SIEMENS



Celebrate Life, while we Care.

Betagard 5SV

Residual Current Circuit Breakers



In the event of a fault,
residual current protective
devices reliably disconnect
power to protect humans

Fault protection

"Protection against indirect contact"

Protects people in the event of contact with electrically conductive parts, if a risk exists as a result of a fault due to the magnitude or duration of the touch voltage



Additional protection

"Protection in case of direct contact" with $I_{\Delta n} = 30\text{mA}$

Protects individuals if they come in direct contact with an active live part under normal operating condition



Fire protection

"Protection from insulation faults" with $I_{\Delta n} = 300\text{mA}$

For the prevention of fires which can be caused by insulation faults in locations exposed to fire hazards



Surge current withstand capability

"Protection surge currents" with $8/20\mu\text{s} > 1000\text{Amp}$

For Type "A"  have a surge current capability to avoid nuisance tripping





Betagard Residual Current Circuit Breakers 5SV





- Standards: IS 12640 (Part 1):2016/ IEC 61008-1:2012
- Voltage: 240/415V AC, 50Hz
- With ISI marking: CM/L No. 7676092

Type AC, applicable in networks for AC residual currents

	Rated residual current $I_{\Delta n}$ (mA)	Rated Current I_n (A)	MW#	Reference No	Unit MRP* ₹	Std. Pkg.** (Nos.)	
	2 Pole	30	25	2	5SV43120RC	4310.-	1
		100	25		5SV44120RC	4500.-	1
		300	25		5SV46120RC	4650.-	1
		30	40		5SV43140RC	5050.-	1
		100	40		5SV44140RC	5275.-	1
		300	40		5SV46140RC	5475.-	1
		30	63		5SV43160RC	6755.-	1
		100	63		5SV44160RC	6805.-	1
		300	63		5SV46160RC	7235.-	1
		30	80		5SV43170RC	10445.-	1
		100	80		5SV44170RC	10860.-	1
		300	80		5SV46170RC	10860.-	1
	4 Pole	30	25	4	5SV43420RC	5775.-	1
		100	25		5SV44420RC	5985.-	1
		300	25		5SV46420RC	6205.-	1
		30	40		5SV43440RC	5840.-	1
		100	40		5SV44440RC	6065.-	1
		300	40		5SV46440RC	6300.-	1
		30	63		5SV43460RC	6805.-	1
		100	63		5SV44460RC	7075.-	1
		300	63		5SV46460RC	7330.-	1
		30	80		5SV43470RC	10445.-	1
		100	80		5SV44470RC	10860.-	1
		300	80		5SV46470RC	10860.-	1

Type A, applicable in networks with AC and/or pulsating DC residual currents

	2 Pole	30	25	2	5SV33126RC	7880.-	1
		100	25		5SV34126RC	9290.-	1
		300	25		5SV36126RC	9290.-	1
		30	40		5SV33146RC	8940.-	1
		100	40		5SV34146RC	9310.-	1
		300	40		5SV36146RC	9310.-	1
		30	63		5SV33166RC	13000.-	1
		100	63		5SV34166RC	13365.-	1
		300	63		5SV36166RC	12730.-	1
		30	80		5SV33176RC	13980.-	1
		100	80		5SV34176RC	15040.-	1
		300	80		5SV36176RC	14320.-	1
	4 Pole	30	25	4	5SV33426RC	9345.-	1
		100	25		5SV34426RC	11535.-	1
		300	25		5SV36426RC	11535.-	1
		30	40		5SV33446RC	10320.-	1
		100	40		5SV34446RC	11535.-	1
		300	40		5SV36446RC	11535.-	1
		30	63		5SV33466RC	11790.-	1
		100	63		5SV34466RC	11710.-	1
		300	63		5SV36466RC	11710.-	1
		30	80		5SV33476RC	14170.-	1
		100	80		5SV34476RC	15040.-	1
		300	80		5SV36476RC	14320.-	1

■ Stock items

Note:

* MRP - Maximum Retail Price # 1MW (Module Width) = 18mm

** Purchase MOQ for our authorized dealers is in multiples of standard packing, contact Siemens Sales Office for further details

Residual Current Devices

SENTRON 5SM2

Residual Current Units

NEW



RC Units suitable with 5SL7..RC MCBs for complete protection from Residual current, Over load and Short circuit faults



Easy and Fast Installation



Reduced Inventory with range up to 63A in two variants only

Wide portfolio catering to various applications



Confirming to
- IEC/EN 61009-1
- IEC/EN 61009-2-1
- IEC/EN 61543



RoHS compliant





SENTRON Residual Current Units 5SM2



NEW

- Standards: In accordance with IEC/EN 61009-1 (VDE 0664-20), IEC/EN 61009-2-1 (VDE 0664-21), IEC/EN 61543 (VDE 0664-30)
- Voltage: 240/415V AC, 50Hz

Type AC, applicable in networks for AC residual currents

	Number of poles	Mounting width MW#	Rated residual current I _{Δn} [mA]	RC Unit-Current Rating [A]	5SL7..RC MCBs- Rated current [A]	Reference No	Unit LP* ₹	Std. Pkg.** (Nos.)
	2	2	10	40	2- 40	5SM21210RC	4110.-	1
			30	40	2- 40	5SM23220RC	3640.-	1
				63	2- 63	5SM23250RC	5980.-	1
			100	40	2- 40	5SM24220RC	4490.-	1
			63	2- 63	5SM24250RC	6515.-	1	
			300	40	2- 40	5SM26220RC	3620.-	1
				63	2- 63	5SM26250RC	5835.-	1
	3	3	30	40	2- 40	5SM23320RC	4095.-	1
				63	2- 63	5SM23350RC	6175.-	1
			100	40	2- 40	5SM24320RC	4885.-	1
				63	2- 63	5SM24350RC	6725.-	1
			300	40	2- 40	5SM26320RC	5100.-	1
				63	2- 63	5SM26350RC	6880.-	1
	4	3	30	40	2- 40	5SM23420RC	4450.-	1
				63	2- 63	5SM23450RC	5775.-	1
			100	40	2- 40	5SM24420RC	5200.-	1
				63	2- 63	5SM24450RC	6025.-	1
			300	40	2- 40	5SM26420RC	5415.-	1
				63	2- 63	5SM26450RC	6180.-	1

Type A, applicable in networks with AC and/or pulsating DC residual currents

	Number of poles	Mounting width MW#	Rated residual current I _{Δn} [mA]	RC Unit-Current Rating [A]	5SL7..RC MCBs- Rated current [A]	Reference No	Unit LP* ₹	Std. Pkg.** (Nos.)
	2	2	10	40	2- 40	5SM21216RC	4185.-	1
			30	40	2- 40	5SM23226RC	3650.-	1
				63	2- 63	5SM23256RC	6210.-	1
			100	40	2- 40	5SM24226RC	4885.-	1
			63	2- 63	5SM24256RC	5515.-	1	
			300	40	2- 40	5SM26226RC	5100.-	1
				63	2- 63	5SM26256RC	5725.-	1
	3	3	30	40	2- 40	5SM23326RC	4140.-	1
				63	2- 63	5SM23356RC	6335.-	1
			100	40	2- 40	5SM24326RC	4940.-	1
				63	2- 63	5SM24356RC	6895.-	1
			300	40	2- 40	5SM26326RC	5150.-	1
				63	2- 63	5SM26356RC	7055.-	1
	4	3	30	40	2- 40	5SM23426RC	4970.-	1
				63	2- 63	5SM23456RC	5925.-	1
			100	40	2- 40	5SM24426RC	5400.-	1
				63	2- 63	5SM24456RC	6180.-	1
			300	40	2- 40	5SM26426RC	5625.-	1
				63	2- 63	5SM26456RC	6340.-	1

■ Stock items

Note: * LP - List Price

1MW (Module Width) = 18mm

** Purchase MOQ for our authorized dealers is in multiples of standard packing, contact Siemens Sales Office for further details

**Note: To be used along with 5SL7..RC MCBs. MCBs to be ordered separately.
For MCB prices, refer Page no. 8 & 9 from this pricelist.**

Accessories for Remote control mechanism units for 5SM2 RC Units

Remote control mechanism unit:

Adapter- Mount-on device for combination of RC Units 5SM2..RC and MCBs 5SL7..RC.

Item Description	Mounting width MW#	Reference No	Std. Pkg. ** (Nos.)
RC Mech. Power- 5ST3055 & RC Mech. ARD*- 5ST3057 For 2P- 12 V -30 V AC 12 V -48V DC	2	5ST3820-3 + 5ST3820-6	1
RC Mech. Power- 5ST3055 & RC Mech. ARD*- 5ST3057 For 3P & 4P- 12 V -30 V AC 12 V -48V DC	2	5ST3820-3 + 5ST3820-7	1
RC Mech. Power- 5ST3056 & RC Mech. ARD*- 5ST3058 For 2P- 230 V AC	2	5ST3820-3 + 5ST3820-6	1
RC Mech. Power- 5ST3056 & RC Mech. ARD*- 5ST3058 For 3P & 4P- 230 V AC	2	5ST3820-3 + 5ST3820-7	1
RC Mech. Power- 5ST3070 For 2P- 12 V -30 V AC 12 V -48V DC	2	5ST3820-3 + 5ST3820-6	1
RC Mech. Power- 5ST3070 For 3P & 4P- 12 V -30 V AC 12 V -48V DC	2	5ST3820-3 + 5ST3820-7	1

*- Auto Reclose Device

1MW (Module Width) = 18mm

** Purchase MOQ for our authorized dealers is in multiples of standard packing, contact Siemens Sales Office for further details

Note: All accessories can be mounted on the right-hand side of the RC Unit+MCB assembled device.

Note: For pricing details of above mentioned MLFBs and for other 5SM2 accessories, Pl refer Page No. 24 of this Pricelist.

Betagard Residual Current Breaker Operators 5SU1, 10kA





- Standards: IS 12640, Part 2:2016/ IEC 61009-1:2012
- Voltage: 240/415V AC, 50Hz
- With ISI marking: CM/L No. 7676193

Type AC, with C Characteristics (in 2 module size)⁵

	Rated residual current I _{Δn} (mA)	Rated Current I _n (A)	MW#	Reference No	Unit MRP* ₹	Std. Pkg.** (Nos.)
	30	6	2	5SU13541RC06	7460.-	1
	30	10		5SU13541RC10	7460.-	1
	30	16		5SU13541RC16	7460.-	1
	30	20		5SU13541RC20	7460.-	1
	30	25		5SU13541RC25	7460.-	1
	30	32		5SU13541RC32	7835.-	1
	30	40		5SU13541RC40	9260.-	1
	300	6		5SU16541RC06	7595.-	1
	300	10		5SU16541RC10	7595.-	1
	300	16		5SU16541RC16	7595.-	1
	300	20		5SU16541RC20	7595.-	1
	300	25		5SU16541RC25	7595.-	1
	300	32		5SU16541RC32	7990.-	1
	300	40		5SU16541RC40	9445.-	1

Type AC with C characteristic

	240V AC; 50Hz; 2 pole	30	32	4	5SU13241RC32	8240.-	1
		40	5SU13241RC40		9600.-	1	
		63	5SU13241RC63		11155.-	1	
	100	32	5SU14241RC32		9095.-	1	
		40	5SU14241RC40		10220.-	1	
		63	5SU14241RC63		11915.-	1	
	300	32	5SU16241RC32		9185.-	1	
		40	5SU16241RC40		10320.-	1	
		63	5SU16241RC63		11915.-	1	

	415V AC; 50Hz; 4 pole	30	32	7	5SU13441RC32	11005.-	1
		40	5SU13441RC40		11205.-	1	
		63	5SU13441RC63		13295.-	1	
	100	32	5SU14441RC32		11140.-	1	
		40	5SU14441RC40		11355.-	1	
		63	5SU14441RC63		13050.-	1	
	300	32	5SU16441RC32		11230.-	1	
		40	5SU16441RC40		11450.-	1	
		63	5SU16441RC63		13175.-	1	

Type AC with D characteristic

	240V AC; 50Hz; 2 pole	30	32	4	5SU13242RC32	10625.-	1
		40	5SU13242RC40		11640.-	1	
		63	5SU13242RC63		14035.-	1	
	100	32	5SU14242RC32		12860.-	1	
		40	5SU14242RC40		14075.-	1	
		63	5SU14242RC63		16070.-	1	
	300	32	5SU16242RC32		12565.-	1	
		40	5SU16242RC40		14075.-	1	
		63	5SU16242RC63		16095.-	1	

	415V AC; 50Hz; 4 pole	30	32	7	5SU13442RC32	14550.-	1
		40	5SU13442RC40		14770.-	1	
		63	5SU13442RC63		17520.-	1	
	100	32	5SU14442RC32		15750.-	1	
		40	5SU14442RC40		16455.-	1	
		63	5SU14442RC63		18245.-	1	
	300	32	5SU16442RC32		15560.-	1	
		40	5SU16442RC40		16615.-	1	
		63	5SU16442RC63		17865.-	1	

Note: * MRP - Maximum Retail Price # 1MW (Module Width) = 18mm ¹⁾ 1P+N variant
 ** Purchase MOQ for our authorized dealers is in multiples of standard packing, contact Siemens Sales Office for further details
 \$ For connecting accessories with 2P 2M RCBO add handle connector 5ST38051



Betagard Residual Current Breaker Operators 5SU1, 10kA

- Standards: IS 12640, Part 2:2016/ IEC 61009-1:2012
- Voltage: 240/415V AC, 50Hz
- With ISI marking: CM/L No. 7676193



Type A, with C Characteristics (in 2 module size)[§]

	Rated residual current $I_{\Delta n}$ (mA)	Rated Current I_n (A)	MW#	Reference No	Unit MRP* ₹	Std. Pkg.** (Nos.)
	240V AC; 50Hz; 2 pole ¹⁾	30	2	5SU13547RC06	13630.-	1
		30		5SU13547RC10	13630.-	1
		30		5SU13547RC16	13630.-	1
		30		5SU13547RC20	13630.-	1
		30		5SU13547RC25	13630.-	1
		30		5SU13547RC32	14250.-	1
		30		5SU13547RC40	17235.-	1
		300		5SU16547RC06	14035.-	1
		300		5SU16547RC10	14035.-	1
		300		5SU16547RC16	14035.-	1
		300		5SU16547RC20	14035.-	1
		300		5SU16547RC25	14035.-	1
		300		5SU16547RC32	14595.-	1
		300		5SU16547RC40	17600.-	1

Type A with C characteristic

	240V AC; 50Hz; 2 pole	30	4	5SU13247RC32	14930.-	1
				5SU13247RC40	16425.-	1
				5SU13247RC63	18580.-	1
		100		5SU14247RC32	15930.-	1
				5SU14247RC40	17700.-	1
				5SU14247RC63	20110.-	1
		300		5SU16247RC32	15930.-	1
				5SU16247RC40	17700.-	1
				5SU16247RC63	20110.-	1
	415V AC; 50Hz; 4 pole	30	7	5SU13447RC32	18275.-	1
				5SU13447RC40	19030.-	1
				5SU13447RC63	21770.-	1
		100		5SU14447RC32	19615.-	1
				5SU14447RC40	19980.-	1
				5SU14447RC63	22335.-	1
		300		5SU16447RC32	19615.-	1
				5SU16447RC40	20325.-	1
				5SU16447RC63	22685.-	1

Type A with D characteristic

	240V AC; 50Hz; 2 pole	30	4	5SU13248RC32	17420.-	1
				5SU13248RC40	19660.-	1
				5SU13248RC63	22370.-	1
		100		5SU14248RC32	18740.-	1
				5SU14248RC40	20845.-	1
				5SU14248RC63	23750.-	1
		300		5SU16248RC32	18740.-	1
				5SU16248RC40	20845.-	1
				5SU16248RC63	23750.-	1
	415V AC; 50Hz; 4 pole	30	7	5SU13448RC32	21565.-	1
				5SU13448RC40	21835.-	1
				5SU13448RC63	25755.-	1
		100		5SU14448RC32	22715.-	1
				5SU14448RC40	24275.-	1
				5SU14448RC63	26430.-	1
		300		5SU16448RC32	22715.-	1
				5SU16448RC40	24275.-	1
				5SU16448RC63	26435.-	1

Note: * MRP - Maximum Retail Price

1MW (Module Width) = 18mm





¹⁾ 1P+N variant

** Purchase MOQ for our authorized dealers is in multiples of standard packing, contact Siemens Sales Office for further details

§ For connecting accessories with 2P 2M RCBO add handle connector 5ST38051

Betagard Accessories

Accessories for 5SL / 5SY / 5SP MCBs, 5TL Isolators, 5SV RCCBs, 5SM2 RC Units and 5SU1 RCBOs

	Item Description	Reference No	Unit MRP* ₹	Std. Pkg.** (Nos.)	
	Aux contact block (For 5SL/5SY/5SP4/5TL/5SV/5SU1/5SM2)				
	1NO+1NC	5ST3010	1620.-	12	
	2NO	5ST3011	1655.-	1	
	2NC	5ST3012	1655.-	1	
	1CO	5ST3016	2620.-	1	
	Fault signal contact (For 5SL/5SY/5SP4/5SV/5SU1/5SM2)				
	1NO+1NC	5ST3020	2380.-	1	
	2NO	5ST3021	2425.-	1	
	2NC	5ST3022	2425.-	1	
	Shunt release (For 5SL5/5SL7/5SY/5SP4/5SV/5SU1/5SM2)				
110...415V AC	5ST3030	6685.-	1/5		
24...48V DC	5ST3031	6685.-	1/5		
Auxiliary and fault signal changeover contact (5SL/5SY/5SP4/5TL/5SV/5SU1/5SM2)					
Auxiliary switch - 1CO Fault contact - 1CO	5ST3062	7710.-	1		
	Undervoltage release (For 5SL5/5SL7/5SY/5SP4/5SV/5SU1/5SM2)				
	With integrated aux. switch				
	230V AC	5ST3040	8970.-	1/5	
	110V DC	5ST3041	8970.-	1/5	
	24V DC	5ST3042	8970.-	1/5	
	Without integrated aux. switch				
	230V AC	5ST3043	8970.-	1/5	
	110V DC	5ST3044	8970.-	1/5	
	24V DC	5ST3045	8970.-	1/5	
		Remote control mechanism unit			
Basic version for 5SL, 5SY, 5TL1 and 5SU1 (1P+N only) (12-30)V AC & (12-48)V DC, 1.5MW 230V AC, 2MW		5ST3053 5ST3054	40025.- 40025.-	1 1	
Power version for 5SL, 5SY, 5TL1, 5SU1 & 5SM2 (12-30)V AC & (12-48)V DC, 2MW 230V AC, 2MW		5ST3055 5ST3056	67730.- 67730.-	1 1	
Power version for 5SM2 (12-30)V AC & (12-48)V DC, 2MW		5ST3070	79035.-	1	
Auto Reclose Device Version for 5SM2 (12-30)V AC & (12-48)V DC, 2MW 230V AC, 2MW		5ST3057 5ST3058	64865.- 76035.-	1 1	
Adapter for Remote control mechanism (To be ordered along with 5ST305X basic unit) For 5SL - 1P & 2P, 5SV - 4P and 5SM2- 2P		5ST38206	845.-	1	
For 5SL - 3P & 4P and 5SM2 - 3P & 4P		5ST38207	845.-	1	
For 5SY - 1P & 2P and For 5SU1^ - 2P, 4M		5ST38201	845.-	1	
For 5SY - 3P & 4P and For 5SU1^ - 4P, 7M		5ST38202	845.-	1	
For 5SU1 - 2P, 2M		5ST38205	845.-	1	
^ Add-on block for 5SU1 & 5SM2 to be ordered along with Adapter		5ST38203	1840.-	1	
		Handle locking device			
		for 5SP and 5SY circuit breakers for padlock with max. 3mm shackle	5ST3801	830.-	1
		for 5SL circuit breakers, 5TL1 isolators and 5SV residual current circuit breakers for padlock with max. 3 to 6 mm shackle	5ST3806	790.-	5
		Pad locks for 5ST3801 and 5ST3806 handle locking devices	5ST3802	535.-	5
	Handle connector for 2P, 2M 5SU1 RCBO ⁵ (1set = 5 units in poly bag)	5ST38051	1660.-	1	

Betagard Rotary Handle Assembly

	Item Description	Reference No.	Unit MRP* ₹	Std. Pkg.** (Nos.)
	Rotary Handle Assembly for 5SY, 5SL, 5SP and 5TL1 series of MCBs/ Isolators ⁵⁵	5ST38140RC	2977.-	1

Note: * MRP - Maximum Retail Price # 1MW (Module Width) = 18mm

\$ For 2P, 2M RCBOs, the accessories can be used along with Handle connector only

\$\$ Not suitable for 1P variants

** Purchase MOQ for our authorized dealers is in multiples of standard packing, contact Siemens Sales Office for further details

SINOVA Opulenz

Multitasking switches for multitasking homes.

Elegant
finishes to enhance the look of your home.



Premium colours and textures
to complement modern finishes on your walls.



Antibacterial switches
for a safe home.



ISI certified
for assured safety.



Environment friendly
RoHS compliant switches.



Comprehensive communication range
type tested as per standards ensuring higher reliability.



Scan/Click
to know
more!

When homes and offices multitask as online classrooms, home offices, private theaters and more, the Opulenz range multitasks to help you make the most of them. SINOVA Opulenz is a complete range of new age sockets, HDMI receptors, LAN ports, regulators and dimmers in seven exciting colours and two natural textures.



SIEMENS



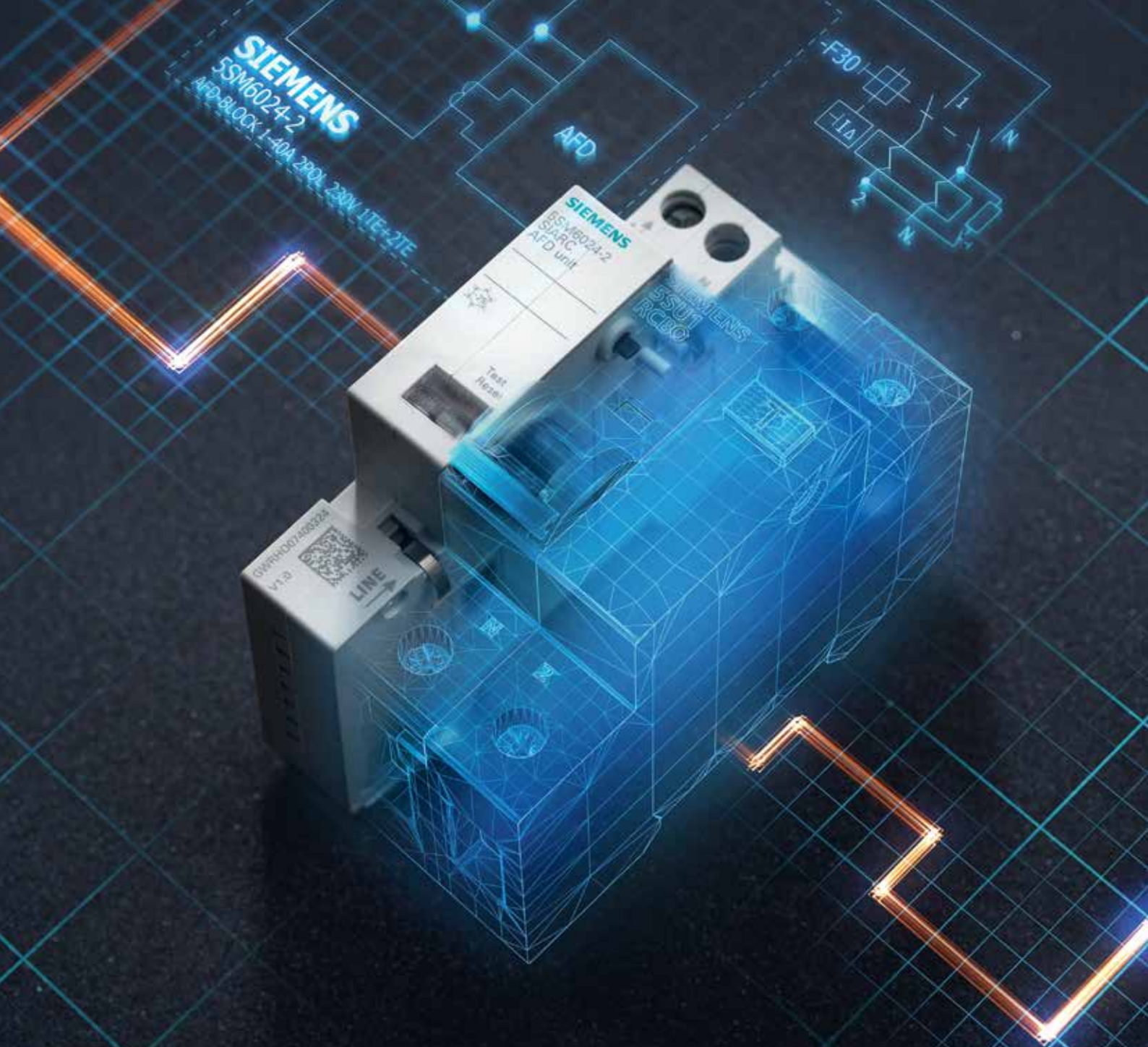

Arc Fault Detection Device

It's Time to Act Now!

With the 5SV6 Arc Fault Detection Device (AFDD), Siemens presents the third generation of fire-prevention product. The 5SV6 Arc Fault Detection Device with integrated miniature circuit breaker (MCB) is the first device on the IEC market with just one module width and is the smallest of its kind worldwide.

A standard-compliant expansion of the electrical installation by protection against electrical fires is thus always possible – easily and without the need for additional space.

www.siemens.com

SIEMENS

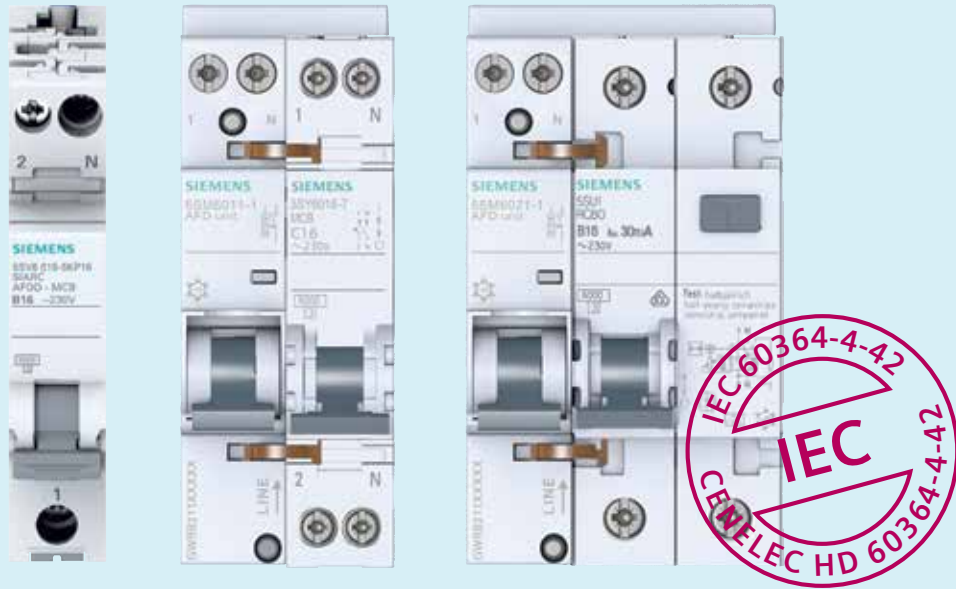

The smart solution.

Whether in an existing plant or a new installation – the 5SV6 AFDD and 5SM6 AFD unit can be deployed in any distribution board. It quickly identifies dangerous faults caused by parallel or serial arcing faults and switches off before a fire occurs. The AFDD detects operational arcing faults and only trips in the event of an actual fault.

5SV6 AFDDs with Integrated MCB & RCBO in 18mm width

	Rating	With integrated MCB		With integrated RCBO	Unit LP* ₹	Std. Pkg.** (Nos.)
		B characteristic	C characteristic	30mA, Type A, C characteristic		
	6A	5SV60166KK06	5SV60167KK06	5SV63167KK06	Price on Request	1
	10A	5SV60166KK10	5SV60167KK10	5SV63167KK10		
	13A	5SV60166KK13	5SV60167KK13	5SV63167KK13		
	16A	5SV60166KK16	5SV60167KK16	5SV63167KK16		
	20A	5SV60166KK20	5SV60167KK20	5SV63167KK20		
	25A	5SV60166KK25	5SV60167KK25	5SV63167KK25		
	32A	5SV60166KK32	5SV60167KK32	5SV63167KK32		
	40A	5SV60166KK40	5SV60167KK40	5SV63167KK40		

5SM6 AFDD with integrated MCB

	Rating	Module width	Reference No.	Description	Unit LP* ₹	Std. Pkg.** (Nos.)
	16A	2	5SM60111XX02	AFDD 16A, 230V, 2MW (Integrated with 1MW, 1+N, 16A MCB)	Price on Request	1

5SM6 AFD units (Suitable for add on with RCBO)

	Rating	Module width	Reference No.	Description	Unit LP* ₹	Std. Pkg.** (Nos.)
	16A	3	5SM60212	AFD Unit 1-16A, 230V, 1MW (Suitable for 2P 2M, 5SU1 RCBO)	Price on Request	1
	40A	3	5SM60242	AFD Unit 1-40A, 230V, 1MW (Suitable for 2P 2M, 5SU1 RCBO)		

* LP - List Price

** Purchase MOQ for our authorized dealers is in multiples of standard packing, contact Siemens Sales Office for further details

SIEMENS

SENTRON Circuit protection devices with measuring and communication function



**SENTRON
5SV6 COM
AFDD/MCB**



**SENTRON
Powercenter 1000
data transceiver**



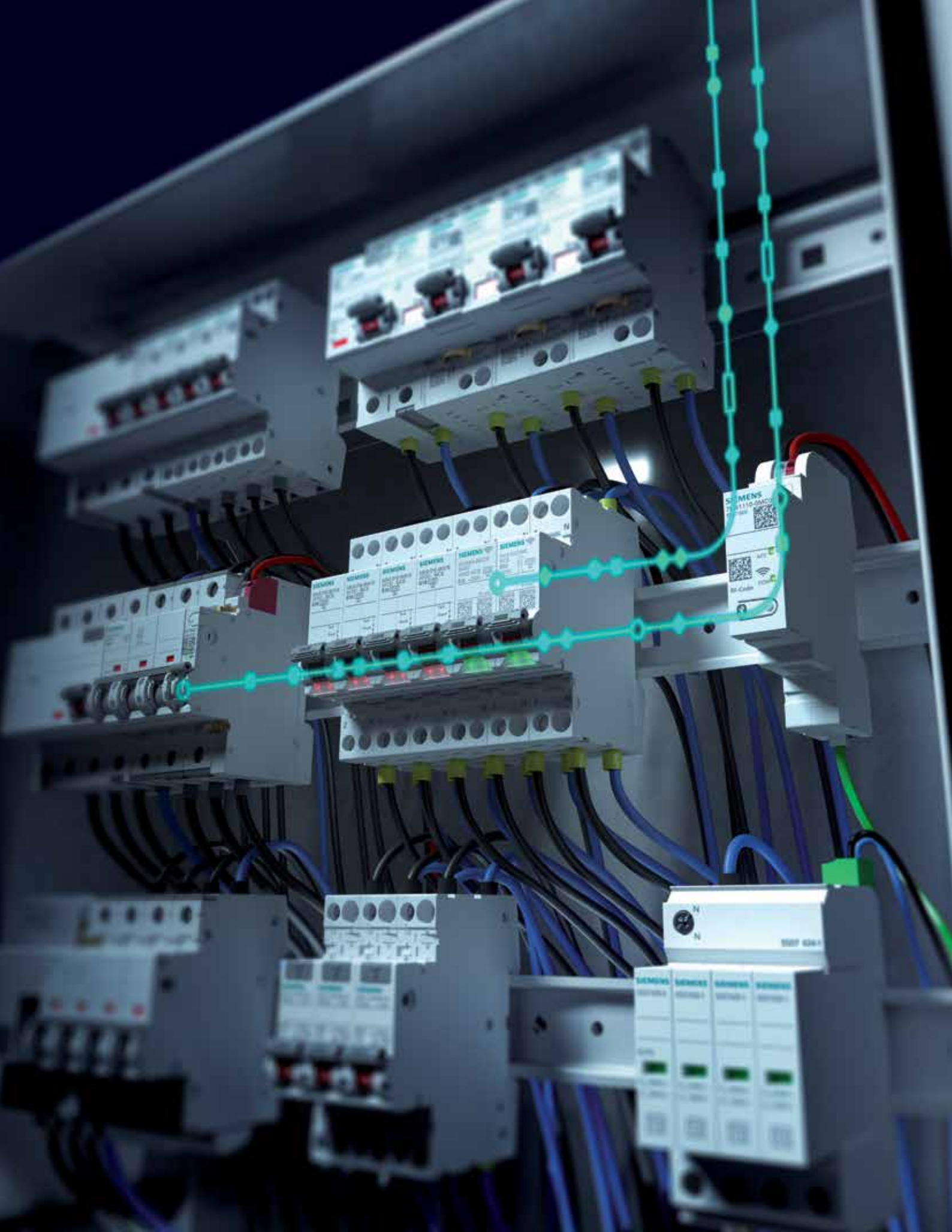

SENTRON AFDD COM 5SV6

	Rating	With integrated MCB		Unit LP* ₹	Std. Pkg.** (Nos.)
		B characteristic	C characteristic		
	6 A	5SV60166MC06	5SV60167MC06	Price on Request	1
	10 A	5SV60166MC10	5SV60167MC10		
	13 A	5SV60166MC13	5SV60167MC13		
	16 A	5SV60166MC16	5SV60167MC16		
	20 A	5SV60166MC20	5SV60167MC20		
	25 A	5SV60166MC25	5SV60167MC25		
	32 A	5SV60166MC32	5SV60167MC32		

SENTRON Powercenter 1000 7KN

	Reference No.	Description	Unit LP* ₹	Std. Pkg.** (Nos.)
	7KN11100MC00	Powercenter1000 max. 24 SENTRON COM devices Modbus TCP Bluetooth Power supply DC 24V	Price on Request	1

* LP - List Price

** Purchase MOQ for our authorized dealers is in multiples of standard packing, contact Siemens Sales Office for further details

Applications:



Operating hours counter

The values measured by the installation device provide information on the electrical consumer's (e.g., an LED) exact operating time allowing for optimized maintenance.



Fault monitoring

A decline of electrical current, voltage or temperature below normal values may hint at a failure of the electrical consumer. An increased electrical current may indicate a defect of connected equipment.



Load management

When a certain number of electrical consumers is active, additional devices cannot be switched on. This prevents current peaks.



Function monitoring

The measured values indicate the execution of an activity by the electrical consumer (e.g., automatic feeders in livestock farming).

SEAMLESS POWER TRANSITIONS, SAFEGUARDING YOUR ENERGY NEEDS

5TR4 Automatic Changeover Current Limiter



Effortlessly manage power transitions with our 5TR4 ACCL, ensuring seamless operations and preventing electrical overload.

Key Features



Heavy Duty-
Conforms to
utilization
category AC32A
(IEC 60947-6-1)



High Endurance
Cycle -Ensuring
efficient and long
life of your ACCL



Safe during Short
circuits - Iq short
circuit of 5kA

Warning &
Alerts -
Overload
indication via
LED & Beep



Standard compliant
Product conforms
to IEC 60947-6-1



Low Power
consumption -
Coil operates
only during
backup supply



For more information-Please contact your nearest Siemens Sales Office.

SIEMENS



Betagard 8GB Distribution Boards

Perfect blend of beauty and features with assured performance







- Complete range for Residential, Commercial and Industrial Infrastructures
- DBs offer latest design with highest aesthetic appeal
- DBs available with type testing as per the latest applicable standards
- User friendly design offers ease during maintenance and assists the installer for correct installation

www.siemens.co.in

SIEMENS

Betagard Distribution Boards 8GB32 # SPN and TPN DBs

- Type Tested as per IEC 61439 Standards at third party and internal test laboratories
- Available in IP 20 and IP 43 Versions
- Single Door, Metal Double Door and Acrylic Double Door options available
- Standard Wire Way Boxes available for all Single Door and Double Door DBs
- Additional safety with Insulated Shorting Links, Shrouded Neutral Links and Door Earthing
- TPN DBs can be easily made suitable for PPI configuration using TPN to PPI Conversion Kits
- Detachable DIN rail assembly and intermittent door facilitates ease in Wiring during installation and maintenance
- DBs are subjected to Seven tank process and treated with premium quality powder coating
- Cement Masking Sheet protects the DBs against extreme site conditions

	Item Description	Incoming Slots (MW)	Outgoing Slots (MW)	Total Slots (MW)	Reference No	Unit MRP* ₹	Std. Pkg.** (Nos.)
Metal Enclosures, IP20:							
	1 Module	-	-	1	8GB32100RC01	915.-	1/20
	2 Module	-	-	2	8GB32100RC02	1360.-	1/20
	3 Module	-	-	3	8GB32100RC03	1360.-	1/20
	4 Module	-	-	4	8GB32100RC04	1360.-	1/20
	6 Module	-	-	6	8GB32100RC06	1795.-	1/20
	8 Module	-	-	8	8GB32100RC08	2115.-	1/10
SPN Single Door DBs#, IP20:							
	6 Module	2	4	6	8GB32101RC06	2690.-	1
	8 Module	2	6	8	8GB32101RC08	2855.-	1
	10 Module	2	8	10	8GB32101RC10	3440.-	1
	12 Module	2	10	12	8GB32101RC12	3560.-	1
	14 Module	2	12	14	8GB32101RC14	4025.-	1
	16 Module	2	14	16	8GB32101RC16	4340.-	1
SPN Metal Double Door DBs#, IP 43:							
	6 Module	2	4	6	8GB32102RC06	4200.-	1
	8 Module	2	6	8	8GB32102RC08	4360.-	1
	10 Module	2	8	10	8GB32102RC10	5075.-	1
	12 Module	2	10	12	8GB32102RC12	5210.-	1
	14 Module	2	12	14	8GB32102RC14	6075.-	1
	16 Module	2	14	16	8GB32102RC16	6225.-	1
SPN Acrylic Double Door DBs#, IP 43:							
	6 Module	2	4	6	8GB32103RC06	4935.-	1
	8 Module	2	6	8	8GB32103RC08	5210.-	1
	10 Module	2	8	10	8GB32103RC10	6075.-	1
	12 Module	2	10	12	8GB32103RC12	6520.-	1
	14 Module	2	12	14	8GB32103RC14	6805.-	1
	16 Module	2	14	16	8GB32103RC16	7095.-	1
Wire Way Box For SPN Single Door IP 20 DBs:							
	For 6 MOD SPN Single door DB	-	-	-	8GB32106RC06	1770.-	1/5
	For 8 MOD SPN Single door DB	-	-	-	8GB32106RC08	1770.-	1/5
	For 10 MOD SPN Single door DB	-	-	-	8GB32106RC10	1910.-	1/5
	For 12 MOD SPN Single door DB	-	-	-	8GB32106RC12	1910.-	1/5
	For 14 MOD SPN Single door DB	-	-	-	8GB32106RC14	2200.-	1/5
	For 16 MOD SPN Single door DB	-	-	-	8GB32106RC16	2200.-	1/5
Wire Way Box For SPN Double Door IP 43 DBs:							
	For 6 MOD SPN Double door DB	-	-	-	8GB32107RC06	1910.-	1/5
	For 8 MOD SPN Double door DB	-	-	-	8GB32107RC08	1910.-	1/5
	For 10 MOD SPN Double door DB	-	-	-	8GB32107RC10	2070.-	1/5
	For 12 MOD SPN Double door DB	-	-	-	8GB32107RC12	2070.-	1/5
	For 14 MOD SPN Double door DB	-	-	-	8GB32107RC14	2635.-	1/5
	For 16 MOD SPN Double door DB	-	-	-	8GB32107RC16	2635.-	1/5

Note: * MRP - Maximum Retail Price # Also available in flat door option
For Customized Solutions in Distribution Boards please Contact our sales Office

** Purchase MOQ for our authorized dealers is in multiples of standard packing, contact Siemens Sales Office for further details

Betagard Distribution Boards 8GB32 # SPN and TPN DBs

	Item Description	Incoming Slots (MW)	Outgoing Slots (MW)	Total Slots (MW)	Reference No	Unit MRP* ₹	Std. Pkg.** (Nos.)
TPN Single Door DBs#, IP20:							
	4 way	8	12	20	8GB32201RC04	6760.-	1
	6 way	8	18	26	8GB32201RC06	7675.-	1
	8 way	8	24	32	8GB32201RC08	9265.-	1
	10 way	8	30	38	8GB32201RC10	13440.-	1
	12 way	8	36	44	8GB32201RC12	13725.-	1
	14 way	8	42	50	8GB32201RC14	15740.-	1
	16 way	8	48	56	8GB32201RC16	16330.-	1
TPN Metal Double Door DBs#, IP 43							
	4 way	8	12	20	8GB32202RC04	8255.-	1
	6 way	8	18	26	8GB32202RC06	9980.-	1
	8 way	8	24	32	8GB32202RC08	11995.-	1
	10 way	8	30	38	8GB32202RC10	17330.-	1
	12 way	8	36	44	8GB32202RC12	17760.-	1
	14 way	8	42	50	8GB32202RC14	21080.-	1
	16 way	8	48	56	8GB32202RC16	21675.-	1
TPN Acrylic Double Door DBs#, IP 43							
	4 way	8	12	20	8GB32203RC04	9980.-	1
	6 way	8	18	26	8GB32203RC06	12285.-	1
	8 way	8	24	32	8GB32203RC08	14735.-	1
	10 way	8	30	38	8GB32203RC10	19220.-	1
	12 way	8	36	44	8GB32203RC12	22370.-	1
	14 way	8	42	50	8GB32203RC14	23965.-	1
	16 way	8	48	56	8GB32203RC16	25575.-	1
TPN to PPI Conversion Kit®							
	To convert 6 way TPN DB to 4 way TPN PPI DB				8GB32205RC04	5210.-	1/5
	To convert 8 way TPN DB to 6 way TPN PPI DB				8GB32205RC06	6075.-	1/5
	To convert 10 way TPN DB to 8 way TPN PPI DB				8GB32205RC08	6225.-	1/5
	To convert 12 way TPN DB to 10 way TPN PPI DB				8GB32205RC10	6650.-	1/5
	To convert 14 way TPN DB to 12 way TPN PPI DB				8GB32205RC12	7095.-	1/5
	To convert 16 way TPN DB to 14 way TPN PPI DB				8GB32205RC14	7510.-	1/5
	Wire Way Box For TPN Single Door IP 20 DBs						
	For 4 Way TPN Single door DB	-	-	-	8GB32206RC04	2200.-	1/5
	For 6 Way TPN Single door DB	-	-	-	8GB32206RC06	2200.-	1/5
	For 8 Way TPN Single door DB	-	-	-	8GB32206RC08	3925.-	1/5
	For 10 Way TPN Single door DB	-	-	-	8GB32206RC10	4935.-	1/5
	For 12 Way TPN Single door DB	-	-	-	8GB32206RC12	5075.-	1/5
	For 14 Way TPN Single door DB	-	-	-	8GB32206RC14	5210.-	1/5
	For 16 Way TPN Single door DB	-	-	-	8GB32206RC16	5520.-	1/5
Wire Way Box For TPN Double Door IP 43 DBs							
	For 4 Way TPN Double door DB	-	-	-	8GB32207RC04	2335.-	1/5
	For 6 Way TPN Double door DB	-	-	-	8GB32207RC06	2635.-	1/5
	For 8 Way TPN Double door DB	-	-	-	8GB32207RC08	4200.-	1/5
	For 10 Way TPN Double door DB	-	-	-	8GB32207RC10	4500.-	1/5
	For 12 Way TPN Double door DB	-	-	-	8GB32207RC12	5520.-	1/5
	For 14 Way TPN Double door DB	-	-	-	8GB32207RC14	5795.-	1/5
	For 16 Way TPN Double door DB	-	-	-	8GB32207RC16	5960.-	1/5

Note: * MRP - Maximum Retail Price

@ Contains required accessories to Make the DB suitable for PPI Configuration
For Customized Solutions in Distribution Boards please Contact our sales Office

** Purchase MOQ for our authorized dealers is in multiples of standard packing, contact Siemens Sales Office for further details

Also available in flat door option

Betagard Distribution Boards 8GB32 TPN Phase Segregated DBs

Item Description	Incoming Slots (MW)	Sub-Incomer Slots (MW)	Outgoing Slots (MW)	Total Slots (MW)	Reference No	Unit MRP* ₹	Std. Pkg.** (Nos.)
TPN Phase segregated DBs, IP 20 For MCB as incomer							
4 Way	12	12	12	36	8GB32001RC04	18615.-	1
6 Way	12	12	18	42	8GB32001RC06	20935.-	1
8 Way	12	12	24	48	8GB32001RC08	24440.-	1
12 Way	12	12	36	60	8GB32001RC12	29095.-	1
TPN Phase segregated DBs, (8 segment) IP 43 For MCB as incomer							
4 way	12	12	12	36	8GB32002RC04	22110.-	1
6 way	12	12	18	42	8GB32002RC06	25600.-	1
8 way	12	12	24	48	8GB32002RC08	29095.-	1
12 way	12	12	36	60	8GB32002RC12	34905.-	1
TPN Phase segregated DBs, IP 43 for MCCB as incomer upto 160A							
6 way		12	18	30	8GB32012RC06	39545.-	1
8 way		12	24	36	8GB32012RC08	45370.-	1
12 way		12	36	48	8GB32012RC12	51190.-	1
Wire Way box for MCB Incomer, IP 43 DBs							
For 4 Way	-	-	-	-	8GB32007RC04	5805.-	1
For 6 Way	-	-	-	-	8GB32007RC06	6970.-	1
For 8 Way	-	-	-	-	8GB32007RC08	8130.-	1
For 12 Way	-	-	-	-	8GB32007RC12	9295.-	1
Wire Way box for MCCB Incomer, IP 43 DBs							
For 6 Way	-	-	-	-	8GB32017RC06	6970.-	1
For 8 Way	-	-	-	-	8GB32017RC08	8130.-	1
For 12 Way	-	-	-	-	8GB32017RC12	9295.-	1

Betagard Distribution Board 8GB

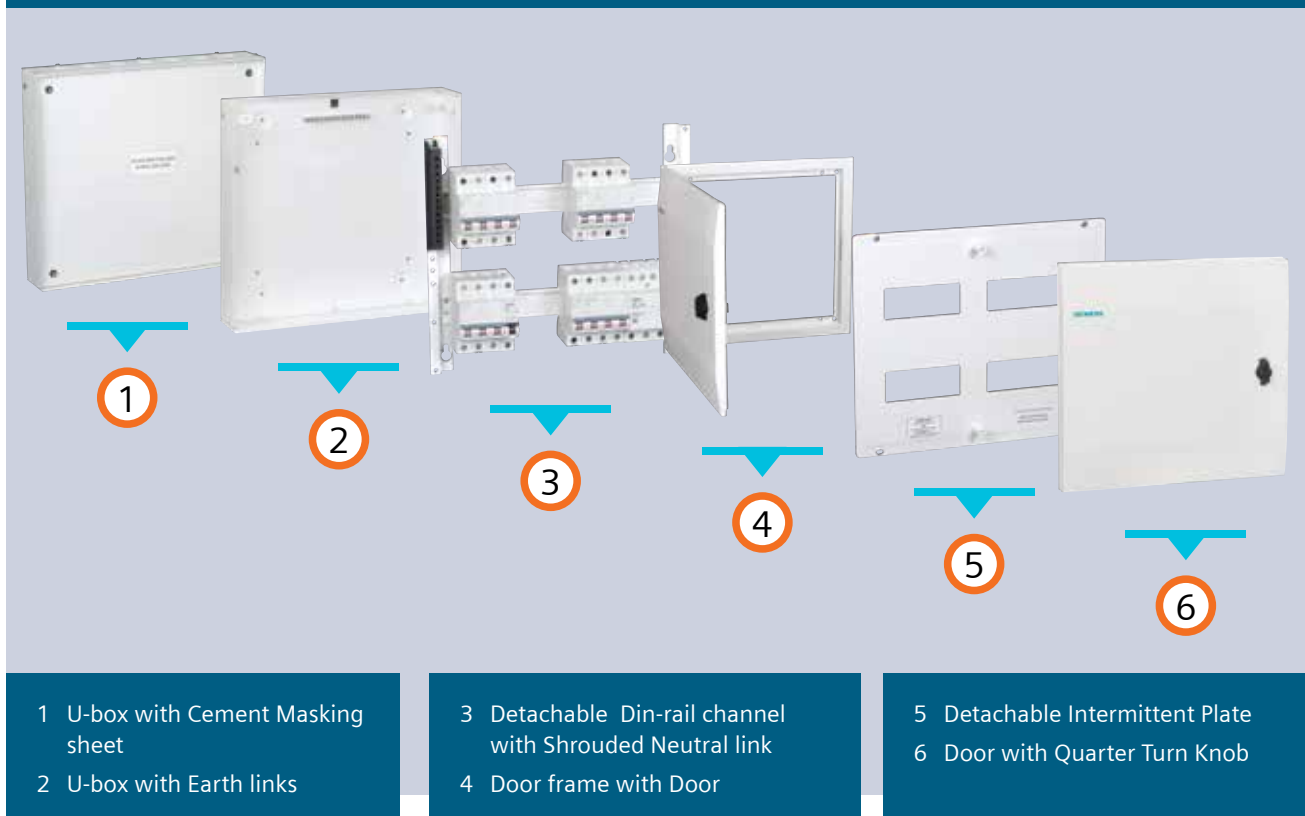

Note: * MRP - Maximum Retail Price

** Purchase MOQ for our authorized dealers is in multiples of standard packing, contact Siemens Sales Office for further details

Industrial plug & sockets

	Item Description	Total Slots (MW)	Reference No	Unit MRP* ₹	Std. Pkg.** (Nos.)
Plug & Socket, IP20 with provision for MCB mounting :					
	1 Phase 20A, 1P MCB	1	8GB0501RC	3020.-	1/20
	1 Phase 20A, 2P MCB	2	8GB0501SRC	3020.-	1/20
	3 Phase 32A, 3P MCB	3	8GB0502	6395.-	1/15
	3 Phase 32A, 3P+N MCB	4	8GB0502S	6395.-	1/15
	5 Pin (3P+N+PE) 3Phase 32A MCB 3P+N MCB	8	8GB050332	10100.-	1/5
	5 Pin (3P+N+PE) 3Phase 63A MCB 3P+N MCB	8	8GB050363	26315.-	1/5

Simbox WP

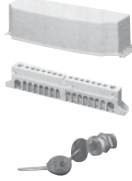
	Item Description	Total Slots (MW)	Reference No	Unit MRP* ₹	Std. Pkg.** (Nos.)
Simbox WP (IP65 DBs)					
	1 Row, 4Mod	4	8GB13710	9085.-	1
	1 Row 8Mod	8	8GB13711	11540.-	1
	1 Row 12Mod	12	8GB13712	20600.-	1
	1 Row 18Mod	18	8GB13713	26680.-	1
	2 Row 2 x 12Mod	24	8GB13722	32940.-	1
	2 Row, 2 x 18Mod	36	8GB13723	46440.-	1
	3 Row, 3 x 18Mod	54	8GB13733	81675.-	1
	4 Row 4 x 18Mod	72	8GB13743	107010.-	1
Accessories for Simbox WP					
	Coupling covers, 12M		8GB20510	2970.-	1
	Coupling covers, 18M		8GB20511	3335.-	1
	Insulated N/PE terminals, 8MW		8GB20520	4630.-	1
	Insulated N/PE terminals, 12MW		8GB20521	7080.-	1
	Insulated N/PE terminals, 18MW		8GB20522	10405.-	1
	Cylindrical security lock		8GB20550	8445.-	1







Note: * MRP - Maximum Retail Price

For Customized Solutions in Distribution Boards please Contact our sales Office

** Purchase MOQ for our authorized dealers is in multiples of standard packing, contact Siemens Sales Office for further details



Betagard Distribution Boards Accessories

	Item Description	Reference No	Unit MRP* ₹	Std. Pkg.** (Nos.)
Blanking Plate				
	1 MW	8GB9901	115.-	25
Insulated Shorting Links				
Single Phase Shorting Links for Shorting 1P MCBs				
For SPN and TPN PPI DB				
	5 Leg SP Shorting Link	8GB9905LSP	350.-	10
	7 Leg SP Shorting Link	8GB9907LSP	415.-	10
	9 Leg SP Shorting Link	8GB9909LSP	485.-	10
	11 Leg SP Shorting Link	8GB9911LSP	510.-	10
	13 Leg SP Shorting Link	8GB9913LSP	685.-	10
	15 Leg SP Shorting Link	8GB9915LSP	830.-	10
	17 Leg SP Shorting Link	8GB9917LSP	870.-	10
For TPN DB				
	4 Leg SP Shorting Link	8GB9904LSP	350.-	10
	6 Leg SP Shorting Link	8GB9906LSP	415.-	10
	8 Leg SP Shorting Link	8GB9908LSP	485.-	10
	10 Leg SP Shorting Link	8GB9910LSP	510.-	10
	12 Leg SP Shorting Link	8GB9912LSP	685.-	10
	14 Leg SP Shorting Link	8GB9914LSP	830.-	10
	16 Leg SP Shorting Link	8GB9916LSP	870.-	10
Two Phase, 1 meter long for shorting 2P MCBs (suitable for maximum of 28 nos. 2MW devices)				
	Shorting link without End caps, Can be cut and used.	8GB990SLDLP	8610.-	1
	End Caps for 2 pole Shorting Links	8GB990ECLDP	145.-	10
Three Phase, 1 meter long for shorting 3P MCBs (suitable for maximum of 19 nos. 3MW devices)				
	Shorting link without Enc caps, Can be cut and used.	8GB990SLLTP	9420.-	1
	End Caps for 3 pole Shorting Links	8GB990ECLTP	210.-	10
Three Phase + N, 1 meter long for shorting TPN MCBs (suitable for maximum of 14 nos. 4MW devices)				
	Shorting link without Enc caps, Can be cut and used.	8GB990SLLTPN	9955.-	1
	End Caps for 3 pole Shorting Links	8GB990ECLTPN	265.-	10
Neutral Terminals				
Neutral Terminals For 8GB0 and 8GB31 DBs (Along with Mounting Stands)				
	5 Way Neutral Link	8GB9905NL	380.-	10
	11 Way Neutral Link	8GB9911NL	560.-	10
	13 Way Neutral Link	8GB9913NL	640.-	10
	15 Way Neutral Link	8GB9915NL	720.-	10
Neutral Terminals For 8GB32 DBs (With Terminal Shroud and Cover)				
	Neutral Terminal 5 Holes	8GB9905NPE	415.-	10
	Neutral Terminal 11 Holes	8GB9911NPE	570.-	10
	Neutral Terminal 13 Holes	8GB9913NPE	685.-	10
	Neutral Terminal 15 Holes	8GB9915NPE	755.-	10
Earth Terminals				
	5 Way Earth Link	8GB9905EL	320.-	10
	11 Way Earth Link	8GB9911EL	540.-	10
	13 Way Earth Link	8GB9913EL	570.-	10
	15 Way Earth Link	8GB9915EL	685.-	10

Note: * MRP - Maximum Retail Price

** Purchase MOQ for our authorized dealers is in multiples of standard packing, contact Siemens Sales Office for further details



Scan/Click
to know
more!

SINOVA

Simply Efficient

Complete range of LV Switchgear products

www.siemens.co.in

SIEMENS



5SD Surge Protection Devices

Safe & Reliable

Surge Protection Devices are available in the following types:

Type 1 - For incoming power supply panels, in buildings with lightning protection system. Must be accompanied by downstream SPD

Type 2 - For distribution panels located downstream of Type 1 protectors or in incoming supply panels in areas of low exposure to lightning strikes, where the building is not fitted with lightning protection system

Type 3 - Always installed downstream of Type 2 protection designed to protect sensitive equipment or equipment located more than 20m downstream of Type 2 SPD

Surge Protection Devices

For protection of equipment against Lightning and Switching surges

- Standard: IEC 61643-11 / EN 61643-11
- Type 1, Type 2 and Photovoltaic surge protection
- With Remote signaling contact
- Integrated SPD health indicator

Type 1: Lightning Surge Arresters

- Maximum continuous operating voltage U_c : 350V



Reference No.	Rated voltage	Pole	Module width	Total I_{imp} (10/350 μ s)	I_{max} (8/20 μ s)	Remote status	Unit LP* ₹
5SD74121RC	240V AC	1P+N	4	50kA	50kA	Yes	23555.-
5SD74141RC	240/415V AC	3P+N	8	100kA	50kA	Yes	45850.-

Type 2: Surge Arresters



Reference No.	Rated voltage	Pole	Module width	U_c	I_{max} (8/20 μ s)	Remote status	Unit LP* ₹
5SD74610RC	240V AC	1P	1	335V AC	20kA	No	3850.-
5SD74640RC	240/415V AC	3P+N	4	335V AC	40kA	No	11450.-

Surge Arresters for Photovoltaic application

On the DC side, over voltage protection is required for the inverters which can be ensured by using 5SD74836RC.

On the AC side, the over voltage protection can be ensured using surge arresters Type 2 (5SD7461-0RC/5SD7464-0RC)



Reference No.	Rated voltage	Pole	Module width	U_{cpv}	I_{max} (8/20 μ s)	Remote status	Unit LP* ₹
5SD74836RC	1170V DC	L+ and L-	3	1170V DC	40kA	No	6505.-

Note: Standard packing: 1 unit

*LP: List Price



Surge Protection Devices

For protection of equipment against Lightning and Switching surges

Type 1: Lightning Surge Arresters

For TN-S/ TT system

Lightning arresters, Type 1 requirement class B, U_c 350V Pluggable protective modules 4-pole, 3+1 circuit for TN-S and TT systems with remote display



5SD74121



5SD74141

Rated voltage U_N	Backup fuse rating	Protection level	Lightening impulse current $I_{imp}(10/350\mu s)$		Pole	Reference No.	Unit LP* ₹
			L-N or L-(PE), 1P/3P	N-PE			
240V AC	125A gL/gG	1.5-2.5kV	25kA	100kA	1P+N	5SD74121	Price on request
240/415V AC	125A gL/gG	1.5-2.5kV	25kA/75kA	100kA	3P+N	5SD74141	

For TN-C system

Lightning arresters, Type 1 requirement class B, U_c 350V Pluggable protective modules 3-pole, 3+0 circuit for TNC systems with remote display



5SD74131

Rated voltage U_N	Backup fuse rating	Protection level	Lightening impulse current $I_{imp}(10/350\mu s)$		Pole	Reference No.	Unit LP* ₹
			L-N or L-(PE), 1P/3P	N-PE			
240/415V AC	125A gL/gG	$\leq 1.5kV$	25kA/75kA	-	3P	5SD74131	112535.-

Type 2 : Surge Arresters

For TN-S/ TT system

Surge arrester Type 2 requirement class C, U_c :350V/260V (L-N/N-PE) Pluggable protective modules 4-pole, 3+1 circuit for TN-S and TT AC systems

Rated Discharge Surge Current $I_n=20kA$ SC capacity with backup fuse=25kA



5SD74641



5SD7422-0

Rated voltage U_N	Backup fuse rating	Protection level U_p	Rated discharge current I_n (8/20usec)		Pole	Remote signaling	Reference No.	Unit LP* ₹
			L-N or L-(PE), 1P/3P	N-PE				
240/415V	80A gL/gG	1.5-1.9kV	40kA	40kA	3P+N	No	5SD74640	Price on request
240/415V	80A gL/gG	1.5-1.9kV	40kA	40kA	3P+N	Yes	5SD74641	
240V	80A gL/gG	1.5-1.9kV	20kA	20kA	1P+N	No	5SD74220	
240V	80A gL/gG	1.5-1.9kV	20kA	20kA	1P+N	Yes	5SD74221	

For TN-C system

Surge arrester Type 2 requirement class C, U_c :350V Pluggable protective modules 3-pole, 3+0 circuit for TNC systems



5SD7463-0

Rated voltage U_N	Backup fuse rating	Protection level U_p	Maximum discharge surge current I_{max}	Pole	Remote signaling	Reference No.	Unit LP* ₹
			L-N or L-(PE)N, 1P				
240/415V	80A gL/gG	$\leq 1.5kV$	40kA	3P	No	5SD74630	38130.-
240/415V	80A gL/gG	$\leq 1.5kV$	40kA	3P	Yes	5SD74631	39875.-

L - Line, N - Neutral, PE - Protective Earth

Note: Standard packing: 1unit

* LP : List Price

Surge Protection Devices

For protection of equipment against Lightning and Switching surges

Type 3 : Surge Arresters

	Rated voltage	Rated current	Protection level	Rated discharge current	Pole	Reference No.	Unit LP* ₹
	24V AC 34V DC	26A	0.65kV	1kA	2P	5SD74325	18075.-
	120V AC 150V DC	26A	0.95kV	3kA	2P	5SD74326	19695.-
	240V AC 240V DC	26A	1.5kV	3kA	2P	5SD74327	20220.-

Surge arresters for photovoltaic application

Due to the combination of three power varistors, the overvoltage protection required for the inverters is implemented on the DC side. On the AC side, the overvoltage protection can be ensured using surge arresters type 2 (5SD7422-/5SD7424-)

	Rated voltage U _N	Rated discharge current	Protection level U _p	Lightning Impulse current (L-N/L-(PE)N)	Max. discharge current	Pole	Remote signaling	Reference No.	Unit LP* ₹
 5SD74836	1000V DC	15kA	≤3.5kV	≤5kA	40kA	3P	No	5SD74836	Price on request

Replacement Plug

	SPD Type	Type	Connection	Reference No.	Unit LP* ₹
	5SD74121	Type 1	L-N	5SD74181	31725.-
	5SD74131				
	5SD74141				
	5SD74121		N-PE	5SD74180	33255.-
	5SD74131				
	5SD74141				
	5SD7463-0/1	Type 2	L-N	5SD74681	9315.-
	5SD7464-0/1				
	5SD7464-0/1		N-PE	5SD74880	11685.-
	5SD7422-0/1				
	5SD7422-0/1	L-N	5SD74281	9315.-	
	5SD7422-0/1				
5SD7422-0/1	N-PE	5SD74280	12130.-		
5SD7483-6				PV	-

* Also available Type 1+ Type 2 and Type1/2 Compact SPDs for protection against overvoltages from Lightning strikes as well as by switching operations in network

Note:

Standard packing: 1unit

* LP - List Price



SENTRON Modular Devices



For efficient control and monitoring

- 7LF time switch - Digital and Analog timers for all applications; available in Mini, Top, Profi, Astro, Expert and Expert GPS variants
- 5TT5 insta contactors – For all control applications; also with Manual/Automatic switching indicator
- DIN mounted phase indicators, monitoring relays and measuring devices for final distribution circuits
- Twilight Switch for Automatic Street Light Control

www.siemens.co.in

SIEMENS

Modular Devices

	Item Description	Rated Current I _n (A)	MW#	Reference No	Unit LP* ₹	Std. Pkg.** (Nos.)
Changeover switches						
Standards: IEC 60947-3/DIN EN 60947-3						
	1C/O, 230V	20	1	5TE8161	3915.-	1/10
	2C/O, 400V	20	1	5TE8162	5915.-	1/10
	Group switch, center position, 2C/O, 400V	20	1	5TE8142	7145.-	1/10
Insta Contactors						
Standards: EN 60947-4-1, EN 60947-5-1						
	2NO contacts, 230V AC	20	1	5TT58000	4725.-	1/5
	3NO+1NC contacts, 230V AC/220V DC (1NC contact rated for 30A)	40	3	5TT58410	12925.-	1/5
	3NO+1NC contacts, 24V AC/24V DC (1NC contact rated for 30A)	40	3	5TT58412	12985.-	1/5
	4NO contacts, 230V AC/220V DC	40	3	5TT58400	13025.-	1/5
	4NO contacts, 24V AC/24V DC	40	3	5TT58402	13005.-	1/5
	3NO+1NC contacts, 230V AC/220V DC (1NC contact rated for 30A)	63	3	5TT58510	20235.-	1/5
	3NO+1NC contacts, 24V AC/24V DC, (1NC contact rated for 30A)	63	3	5TT58512	20605.-	1/5
	4NO contacts, 230V AC/220V DC	63	3	5TT58500	16505.-	1/5
4NO contacts, 24V AC/24V DC	63	3	5TT58502	16540.-	1/5	
Insta Contactors Manual / Automatic with Switching Indicator						
Standards: IEC60947-4-1, IEC60947-5-1						
	2NO contacts, 230V AC	20	1	5TT58006	6290.-	1/5
	1NO+1NC contacts, 230V AC	20	1	5TT58016	9245.-	1/5
	4NO contacts, 230V AC	25	2	5TT58306	9505.-	1/5
	4NO contacts, 400V AC	40	3	5TT58406	19130.-	1/5
	4NO contacts, 400V AC	63	3	5TT58506	25065.-	1/5
Accessories						
	Control Switch with 1 Make and 1 Break Contact For AC 230V/400V For 5TT58 and 5TT50			5TT59101	5765.-	1/10





Note:

* LP - List Price # 1MW (Module Width) = 18mm

** Purchase MOQ for our authorized dealers is in multiples of standard packing, contact Siemens Sales Office for further details



Modular Devices



	Item Description	Rated Current I _n (A)	MW#	Reference No	Unit LP* ₹	Std. Pkg.** (Nos.)
Twilight switch						
	Twilight Switch with light sensor 230 V, 50/60 Hz, 1MW, 16A			7LQ2300	Price on request	1
Voltage Relays Standards: IEC 60255, DIN VDE 0435-303						
	Voltage relay for undervoltage monitoring of 1,2,3 phases against N with phase failure detection, Switching thresholds 0.7-0.9xV, not adjustable; 2 C/O contacts, 4A, 230/400V AC	4	2	5TT3402	20940.-	1
	Voltage relay for undervoltage monitoring of 1,2,3 phases against N, short time failure detection with phase failure detection and N conductor monitoring, Switching thresholds 0.8-0.85xV, not adjustable; 2 C/O contacts, 230/400V AC	4	2	5TT3407	38305.-	1
	Voltage relay for over and undervoltage monitoring of 3 phases against N with asymmetry, reverse voltage and phase failure detection with N conductor monitoring and adj. Time delay of 0.1 to 20s, Switching thresholds: U/voltage 0.7-1.1xV, 4% hysteresis, adjustable, O/voltage 0.9-1.1xV, 4% hysteresis, adjustable; 2 C/O contacts, 230/400V AC	4	2	5TT3408	39435.-	1
RYG 3 phase indicator in 1MW						
	3 phase indicator (all with green color cap)		1	5TE5802	5265.-	1/10
	3 phase indicator (red/yellow/green)		1	5TE5803	5010.-	1/10
	Transparent cap (1 set = 3 items, R, Y, G lens)			5TG8070	1345.-	1/10
Power ON Indicator (Economy Version) 230 V AC, 1 Phase						
	Light indicators for max. cable length up to 5 m with 1 red lamp		1	5TE5800	3140.-	1/12
	Light indicators for max. cable length up to 250 m with 1 red lamp		1	5TE5804	3990.-	1/12
	Transparent cap (Red) (1 set 5x each red/transparent)			5TG8061	1735.-	5
	Transparent cap (Green) (1 Set with 5x each green/transparent)			5TG8062	1735.-	5
	Transparent cap (Yellow) (1 Set with 5x each yellow/transparent)			5TG8063	1735.-	5
	Transparent cap (Blue) (1 Set with 5x each blue/transparent)			5TG8064	1735.-	5
Fuse Monitor						
	Fuse monitors with transparent caps for all low voltage fuse systems, 230V AC	4	2	5TT3170	16425.-	1

Note:

* LP - List Price # 1MW (Module Width) = 18mm

** Purchase MOQ for our authorized dealers is in multiples of standard packing, contact Siemens Sales Office for further details

Modular Devices

	Item Description	Rated Current I_n (A)	MW#	Reference No	Unit LP* ₹	Std. Pkg.** (Nos.)
Time Switches (Digital)						
	Mini digital, daily/weekly program, 100 hours reserve, 230V AC	16	1	7LF45015	12225.-	1
	Yearly time switch top digital 230V, 1 channel	16	2	7LF45110	14970.-	1
	Yearly time switch top digital 230V, 2 channel	16	2	7LF45120	28660.-	1
	Weekly time switch profi digital 230V, 1 channel	16	2	7LF45210	26700.-	1
	Weekly time switch profi digital 230V, 2 channel	16	2	7LF45220	34535.-	1
	Weekly time switch astro digital 230V, 1 channel	16	2	7LF45310	26915.-	1
	Weekly time switch astro digital 230V, 2 channel	16	2	7LF45320	45000.-	1
Time Switches (Mechanical) Standards: EN 60730-1						
 7LF53005	Quartz time switch Day 1 NO 230V/50-60Hz 1 MW with power reserve	16	1	7LF53011	16565.-	1
	Synchronous time switches without power reserve, for DIN rail mounting, day disk, 1CO, 230V AC	16	3	7LF53005	9140.-	1
	Quartz-clock time switches with power reserve for DIN rail mounting, day disk, 1CO, 230V AC	16	3	7LF53016	17595.-	1
	Quartz-clock time switches with power reserve for wall mounting, day disk, 1CO, 250V AC	16	—	7LF53050	19245.-	1
	Synchronous time switches without power reserve, for wall mounting, day disk, 1CO, 250V AC	16	—	7LF53010	10850.-	1
Accessories for Digital Time Switches						
	USB adapter and software			7LF49410	44305.-	1
	Data key profi, astro			7LF49411	4510.-	1

Note:

* LP - List Price

1MW (Module Width) = 18mm

** Purchase MOQ for our authorized dealers is in multiples of standard packing, contact Siemens Sales Office for further details





SINOVA

3VJ Moulded Case Circuit Breakers

Simply Efficient

- Rated current: 16A to 630A
- 1 pole, 2 pole, 3 pole & 4 pole versions
- Breaking capacity: 10kA to 55kA
- Thermal magnetic trip unit (FTFM, ATFM)
- Range of internal and external accessories

www.siemens.co.in

SIEMENS

3VJ Moulded Case Circuit Breakers^{\$}

3VJ MCCB, Thermal Magnetic Trip Unit, Fixed Thermal Fixed Magnetic (FTFM), 415V AC, 50Hz

Frame Size	Breaking Capacity @415V AC, 50/60Hz	Rated Current In (A)	3 Pole Type	4 Pole Type		
3VJ10 (VJ1 125X)	18kA	16	3VJ1096-1DA32-0AA0	3VJ1096-1EA42-0AA0		
		20	3VJ1002-1DA32-0AA0	3VJ1002-1EA42-0AA0		
		25	3VJ1092-1DA32-0AA0	3VJ1092-1EA42-0AA0		
		32	3VJ1003-1DA32-0AA0	3VJ1003-1EA42-0AA0		
		40	3VJ1004-1DA32-0AA0	3VJ1004-1EA42-0AA0		
		50	3VJ1005-1DA32-0AA0	3VJ1005-1EA42-0AA0		
		63	3VJ1006-1DA32-0AA0	3VJ1006-1EA42-0AA0		
		80	3VJ1008-1DA32-0AA0	3VJ1008-1EA42-0AA0		
		100	3VJ1010-1DA32-0AA0	3VJ1010-1EA42-0AA0		
		125	3VJ1012-1DA32-0AA0	3VJ1012-1EA42-0AA0		
		3VJ12 (VJ1 250)	25kA	16	3VJ1096-3DA32-0AA0	3VJ1096-3EA42-0AA0
				20	3VJ1002-3DA32-0AA0	3VJ1002-3EA42-0AA0
				25	3VJ1092-3DA32-0AA0	3VJ1092-3EA42-0AA0
				32	3VJ1003-3DA32-0AA0	3VJ1003-3EA42-0AA0
40	3VJ1004-3DA32-0AA0			3VJ1004-3EA42-0AA0		
50	3VJ1005-3DA32-0AA0			3VJ1005-3EA42-0AA0		
63	3VJ1006-3DA32-0AA0			3VJ1006-3EA42-0AA0		
80	3VJ1008-3DA32-0AA0			3VJ1008-3EA42-0AA0		
100	3VJ1010-3DA32-0AA0			3VJ1010-3EA42-0AA0		
125	3VJ1012-3DA32-0AA0			3VJ1012-3EA42-0AA0		
3VJ12 (VJ1 250)	25kA	160	3VJ1216-3DA32-0AA0	3VJ1216-3EA42-0AA0		
		200	3VJ1220-3DA32-0AA0	3VJ1220-3EA42-0AA0		
		250	3VJ1225-3DA32-0AA0	3VJ1225-3EA42-0AA0		

3VJ MCCB, Thermal Magnetic Trip Unit, Adjustable Thermal Fixed Magnetic (ATFM), 415V AC, 50Hz

Frame Size	Breaking Capacity @415V AC, 50/60Hz	Rated Current In (A)	3 Pole Type	4 Pole Type
3VJ10 (VJ1 125X)	25kA	16	3VJ1096-3DB32-0AA0	3VJ1096-3EB42-0AA0
		20	3VJ1002-3DB32-0AA0	3VJ1002-3EB42-0AA0
		25	3VJ1092-3DB32-0AA0	3VJ1092-3EB42-0AA0
		32	3VJ1003-3DB32-0AA0	3VJ1003-3EB42-0AA0
		40	3VJ1004-3DB32-0AA0	3VJ1004-3EB42-0AA0
		50	3VJ1005-3DB32-0AA0	3VJ1005-3EB42-0AA0
		63	3VJ1006-3DB32-0AA0	3VJ1006-3EB42-0AA0
		80	3VJ1008-3DB32-0AA0	3VJ1008-3EB42-0AA0
		100	3VJ1010-3DB32-0AA0	3VJ1010-3EB42-0AA0
		125	3VJ1012-3DB32-0AA0	3VJ1012-3EB42-0AA0
3VJ12 (VJ1 250)	25kA	160	3VJ1216-3DB32-0AA0	3VJ1216-3EB42-0AA0
		200	3VJ1220-3DB32-0AA0	3VJ1220-3EB42-0AA0
		250	3VJ1225-3DB32-0AA0	3VJ1225-3EB42-0AA0
3VJ13 (VJ1 400)	25kA	320	3VJ1332-3DB32-0AA0	3VJ1332-3EB42-0AA0
		400	3VJ1340-3DB32-0AA0	3VJ1340-3EB42-0AA0
3VJ11 (VJ1 125)	36kA	16	3VJ1196-5DB32-0AA0	3VJ1196-5EB42-0AA0
		20	3VJ1102-5DB32-0AA0	3VJ1102-5EB42-0AA0
		25	3VJ1192-5DB32-0AA0	3VJ1192-5EB42-0AA0
		32	3VJ1103-5DB32-0AA0	3VJ1103-5EB42-0AA0
		40	3VJ1104-5DB32-0AA0	3VJ1104-5EB42-0AA0
		50	3VJ1105-5DB32-0AA0	3VJ1105-5EB42-0AA0
		63	3VJ1106-5DB32-0AA0	3VJ1106-5EB42-0AA0
		80	3VJ1108-5DB32-0AA0	3VJ1108-5EB42-0AA0
		100	3VJ1110-5DB32-0AA0	3VJ1110-5EB42-0AA0
		125	3VJ1112-5DB32-0AA0	3VJ1112-5EB42-0AA0
3VJ12 (VJ1 250)	36kA	160	3VJ1216-5DB32-0AA0	3VJ1216-5EB42-0AA0
		200	3VJ1220-5DB32-0AA0	3VJ1220-5EB42-0AA0
		250	3VJ1225-5DB32-0AA0	3VJ1225-5EB42-0AA0
3VJ13 (VJ1 400)	36kA	320	3VJ1332-5DB32-0AA0	3VJ1332-5EB42-0AA0
		400	3VJ1340-5DB32-0AA0	3VJ1340-5EB42-0AA0
3VJ14 (VJ1 630)	36kA	630	3VJ1463-5DB32-0AA0	3VJ1463-5EB42-0AA0

^{\$} Kindly refer latest Power Distribution Products Price List for prices

3VJ Internal accessories⁵

Frame Size	Accessory compartment/ Coil voltage	3VJ10 (VJ1 125X)	3VJ11 (VJ1 125)	3VJ12 (VJ1 250)	3VJ13/14 (VJ1 400/630)
Auxiliary Switches (AUX)	Left	3VJ9018-0AN11	3VJ9218-0AN11	3VJ9218-0AN11	3VJ9417-0AN11
	Right	-	3VJ9218-0AN21	3VJ9218-0AN21	3VJ9417-0AN21
Auxiliary + Alarm Switches (AUX+AL)	Left	3VJ9018-0AD11	3VJ9118-0AD11	3VJ9218-0AD11	3VJ9417-0AD11
	Right	-	3VJ9118-0AD21	3VJ9218-0AD21	3VJ9417-0AD21

3VJ External accessories⁵

Frame Size	Accessory	3VJ10 (VJ1 125X)	3VJ11 (VJ1 125)	3VJ12 (VJ1 250)	3VJ13/14 (VJ1 400/630)
	Extended Door Mounted Rotary Operator (including 8UC handle)	3VJ9018-0HD11	3VJ9118-0HD11	3VJ9218-0HD11	3VJ9417-0HD11
	Enclosure	3VJ9016-ODE11 (2P, 3P)	3VJ9116-ODE11 (2P, 3P)	3VJ9216-ODE12 (2P, 3P)	-
		3VJ9014-ODE11 (4P)	3VJ9114-ODE11 (4P)	3VJ9214-ODE12 (4P)	-

Raja⁺ DOL Starters[@] 3TW Direct On Line Starters

IS/IEC 60947-4-1



CML No.7800027718

3ph, 50Hz DOL Starter in sheet steel housing, including bimetal relay with single phasing protection

	Motor Rating At 415V 3ph 50Hz		Starter Type	Contactors	Thermal Overload Relay	Relay range (A)	Max. Full Load Current (Amp)		Std. Pkg. (Nos.)
	HP	kW					3Ph, 415V 4P Squirrel Cage IS 8789:1996 Table 4	3Ph, 415V 2P MRP Submersible motor IS 9283:1995 Table 2	
	0.33	0.25	3TW7291-1A^64	3TS3010-0A##-08KA0	3UW5102-0J	0.63-1	-	-	1
	0.75	0.55	3TW7291-1A^66	3TS3010-0A##-08KA0	3UW5102-1A	1-1.6	1.7	-	1
	1	0.75	3TW7291-1A^68	3TS3010-0A##-08KA0	3UW5102-1C	1.6-2.5	2.2	-	1
	1.5	1.1	3TW7291-1A^69	3TS3010-0A##-08KA0	3UW5102-1D	2-3.2	2.9	3.25	1
	2	1.5	3TW7291-1A^71	3TS3010-0A##-08KA0	3UW5102-1F	3.2-5	3.8	4.5	1
	3	2.2	3TW7291-1A^72	3TS3010-0A##-08KA0	3UW5102-1G	4-6.3	5.1	6.5	1
	5	3.7	3TW7291-1A^74	3TS3010-0A##-08KA0	3UW5102-1J	6.3-10	8.1	10	1
	7.5	5.5	3TW7291-1A^75	3TS3210-0A##-08KA0	3UW5102-1K	8-12.5	11.4	14.5	1
	7.5	5.5	3TW7291-1A^77	3TS3210-0A##-08KA0	3UW5102-2A	10-16	-	-	1
	10	7.5	3TW7291-1A^78	3TS3210-0A##-08KA0	3UW5102-2B	12.5-20	15.4	19.5	1

^ Enter code for coil voltage, 50Hz (B for 200-400V AC, W for 332 - 456V AC)

Enter Code for operating coil voltage, 50 Hz (Z6 for 200-400V, R0 for 415V)

* MRP - Maximum Retail Price LP - List Price

\$ Kindly refer latest Power Distribution Products Price List for prices

@ Kindly refer latest Control Products Price List for prices

Switch disconnecter fuse[@] Superswitch 3KL8 in open execution 3PN

Switch Disconnector fuse: 3KL8 for power distribution (in Open Execution 3PN)[^]

	Rated current I _e @ 690V AC 50Hz	SDF suitable for DIN type HRC Fuses	SDF suitable for BS type HRC Fuses	SDF suitable for cylindrical type HRC Fuses	Std. pkg. (nos.)
	20A	3KL8111-5TA00	3KL8111-5TJ00	3KL8111-5TC00	1
	32A	3KL8121-5TA00	3KL8121-5TJ00	3KL8121-5TC00	1
	63A	3KL8151-5TA00	3KL8151-5TJ00	3KL8151-5TC00	1
	100A	3KL8171-5TA00	-	-	1
	100A	3KL8211-5TA00	3KL8211-5TJ00	-	1
	125A	3KL8221-5TA00	3KL8221-5TJ00	-	1
	160A	3KL8231-5TA00	3KL8231-5TJ00	-	1
	200A	3KL8311-5UA00	3KL8311-5UJ00	-	1
	250A	3KL8321-5UA00	3KL8321-5UJ00	-	1
	315A	3KL8331-5UA00	3KL8331-5UJ00	-	1
	400A	3KL8341-5UA00	3KL8341-5UJ00	-	1
	500A	3KL8411-5UA00	3KL8411-5UJ00	-	1
	630A	3KL8421-5UA00	3KL8421-5UJ00	-	1
	800A	3KL8431-5UA00	3KL8431-5UJ00	-	1

[^] 3PN is 3 Pole with neutral link

Selection table for SS Housing for 3KL8



	Rated current I _e (A)	Reference No	Unit MRP* ₹	Std. Pkg. (Nos.)
	3KL81 (20A - 63A)	3KX8235-4AC	-	1
	3KL82 (100A - 160A)	3KX8235-4AC	-	1
	3KL83 (200A - 400A)	3KX8345-4AC	-	1
	3KL84 (500A - 800A)	3KX8435-4AC	-	1

Rated current I _e (A)	Gland box Reference No.	Unit MRP* ₹	Gland Plate Reference No.	Unit MRP* ₹	Std Pkg. (Nos.)
3KL81(20A-63A)	3KX8235-4DC	-	3KX8235-4GC	-	1
3KL82(100A-160A)	3KX8235-4DC	-	3KX8235-4GC	-	1
3KL83(200A-400A)	3KX8345-4DC	-	3KX8345-4GC	-	1
3KL84(500A-800A)	3KX8435-4DC	-	3KX8435-4GC	-	1

LV HRC Fuses[@]

DIN Type Fuse



Rated voltage: 500 V AC

	Size	Rated current A	Reference No	Unit MRP* ₹	Std. Pkg. (Nos.)
	000	2	3NA7 802-ORC	-	1/6
		4	3NA7 804-ORC	-	
		6	3NA7 801-ORC	-	
		10	3NA7 803-ORC	-	
		16	3NA7 805-ORC	-	
		20	3NA7 807-ORC	-	
		25	3NA7 810-ORC	-	
		32	3NA7 812-ORC	-	
		40	3NA7 817-ORC	-	
		50	3NA7 820-ORC	-	
	00	63	3NA7 822-ORC	-	
		80	3NA7 824-ORC	-	
		100	3NA7 830-ORC	-	
		125	3NA7 832-ORC	-	
	1	160	3NA7 836-ORC	-	
		50	3NA7 120-ORC	-	1/3
		63	3NA7 122-ORC	-	
		80	3NA7 124-ORC	-	
		100	3NA7 130-ORC	-	
		125	3NA7 132-ORC	-	
		160	3NA7 136-ORC	-	
		200	3NA7 140-ORC	-	
		224	3NA7 142-ORC	-	
250	3NA7 144-ORC	-			

400 & 800A fuses - Rated voltage at 415 V AC

Note: * MRP - Maximum Retail Price

@ Kindly refer latest Power Distribution Products Price List for prices





	Size	Rated current A	Reference No	Unit MRP* ₹	Std. Pkg. (Nos.)
	2	200	3NA7 240-ORC	-	1/3
		250	3NA7 244-ORC	-	
		315	3NA7 252-ORC	-	
		400 [#]	3NA7 260-ORC	-	
	3	315	3NA3 352-ORC	-	1/3
		400	3NA3 360-ORC	-	
		500	3NA3 365-ORC	-	
		630	3NA3 372-ORC	-	
		800 [#]	3NA3 375-4RC	-	

BS Fuses

	Type	Rated current A	Reference No	Unit MRP* ₹	Std. Pkg. (Nos.)
	Offset Tag	2	3NW TIA2	-	20
		4	3NW TIA4	-	
		6	3NW TIA6	-	
		10	3NW TIA10	-	
		16	3NW TIA16	-	
		20	3NW TIA20	-	
		25	3NW TIA25	-	
		32	3NW TIA32	-	
		40	3NW TIS40	-	
		50	3NW TIS50	-	
		63	3NW TIS63	-	

Available till stocks last

Betagard Distribution Boards 8GB31

	Item Description	Incoming Slots (MW)	Outgoing Slots (MW)	Total Slots (MW)	Reference No	Unit MRP* ₹	Std. Pkg.** (Nos.)
Betaflex (Flexi DBs), IP42 :							
	2Row x 12Mod	—	—	24	8GB31424RC	Price on request	1
	2Row x 16Mod	—	—	32	8GB31426RC		1
	4Row x 6Mod	—	—	24	8GB31441RC		1
	4Row x 8Mod	—	—	32	8GB31442RC		1
	4Row x 10Mod	—	—	40	8GB31443RC		1
	4Row x 12Mod	—	—	48	8GB31444RC		1
	4Row x 16Mod	—	—	64	8GB31446RC		1
Betabus (Vertical Busbar DBs with MCB as an incomer), IP42 : (Suitable for 5SL/5SP MCBs, upto 125A as an incomer)							
	4 way	12	12	24	8GB31471RC	Price on request	1
	6 way	12	18	30	8GB31473RC		1
	8 way	12	24	36	8GB31474RC		1
	12 way	12	36	48	8GB31477RC		1
Betabusplus (Vertical Busbar DBs with MCCB as an incomer), IP42 : (Suitable for 3VT1/3VA1 MCCBs, upto 160A as an incomer)							
	4 way	12	12	24	8GB31571RC	Price on request	1
	6 way	12	18	30	8GB31572RC		1
	8 way	12	24	36	8GB31573RC		1
	12 way	12	36	48	8GB31574RC		1
BetaMulti (DBs for power & communication), IP42 :							
	12 way SPN, provision	2	12	14	8GB31215RC	Price on request	1
	4 Way TPN, Provision	8	12	20	8GB31220RC		1
	6 way TPN, provision	8	18	26	8GB31221RC		1
	8 Way TPN Provision	8	24	32	8GB31222RC		1





Note:

* MRP - Maximum Retail Price

** Purchase MOQ for our authorized dealers is in multiples of standard packing, contact Siemens Sales Office for further details

Available till stocks last

Betagard Distribution Boards 8GB31

	Item Description	Incoming Slots (MW)	Outgoing Slots (MW)	Total Slots (MW)	Reference No	Unit MRP* ₹	Std. Pkg.** (Nos.)
Beta CO (DBs with built-in pre-wired phase changeover switches), IP42 :							
	40 A, 4 Way TPN, built-in	8	12	20	8GB31850RC	Price on request	1
	40 A, 6 Way TPN, built-in	8	18	26	8GB31851RC		1
	40 A, 8 Way TPN, built-in	8	24	32	8GB31852RC		1
	40 A, 12 Way TPN, built-in	8	36	44	8GB31854RC		1
	63 A, 4 Way TPN, built-in	8	12	20	8GB31860RC		1
	63 A, 6 Way TPN, built-in	8	18	26	8GB31861RC		1
	63 A, 8 Way TPN, built-in	8	24	32	8GB31862RC		1
	63 A, 12 Way TPN, built-in	8	36	44	8GB31864RC		1
Wire Way Boxes (WWB)							
	WWB for Flexi DB, 8Mod	—	—	—	8GB9908FWWNT	Price on request	1/5
	WWB for Flexi DB, 12Mod	—	—	—	8GB9912FWWNT		1/5
	WWB for Flexi DB, 16Mod	—	—	—	8GB9916FWWNT		1/5
	WWB for Bus DB	—	—	—	8GB99BUSWWNT		1/5
	WWB for Bus Plus DB	—	—	—	8GB99PLUSWWNT		1/5
Modular Device Boxes (MDB)							
	MDB for Flexi DB, 8Mod/Row	—	—	8	8GB9908FMDTC	Price on request	1/5
	MDB for Flexi DB, 12Mod/Row	—	—	12	8GB9912FMDTC		1/5
	MDB for Flexi DB, 16Mod/Row	—	—	16	8GB9916FMDTC		1/5
	MDB for Bus DB	—	—	12	8GB99BUSMBTC		1/5
	MDB for Bus Plus DB	—	—	12	8GB99PLUSMBTC		1/5
BetaMulti (DBs for power & communication), IP42 :							
	12 way SPN, built-in	2	12	14	8GB31315RC	Price on request	1
	4 Way TPN, Built-in	8	12	20	8GB31320RC		1
	6 way TPN, built-in	8	18	26	8GB31321RC		1
	8 Way TPN, Built-in	8	24	32	8GB31322RC		1
Beta CO (DBs with provision for phase changeover switches), IP42 :							
	4 way, with provision	8	12	20	8GB31840RC	Price on request	1
	6 way, with provision	8	18	26	8GB31841RC		1
	8 way, with provision	8	24	32	8GB31842RC		1
	12 way, with provision	8	36	44	8GB31844RC		1

Betagard Distribution Boards Accessories

	Item Description	Reference No	Unit MRP* ₹	Std. Pkg.** (Nos.)
Blanking Plate				
	1.5 MW	8GB9902	Price on request	25

Note:

* MRP - Maximum Retail Price

** Purchase MOQ for our authorized dealers is in multiples of standard packing, contact Siemens Sales Office for further details

Discontinued Products

Betagard Residual Current Circuit Breakers 8GB0

Reference No.	Reference No.	Reference No.	Reference No.
8GB0004	8GB0404HRC	8GB0412VRC	8GB0409VRC
8GB0006	8GB0406HRC	8GB0405HRC	8GB0413VRC
8GB0204RC	8GB0408HRC	8GB0407HRC	8GB0504
8GB0206RC	8GB0412HRC	8GB0409HRC	8GB0506
8GB0208RC	8GB0404VRC	8GB0413HRC	8GB0508
8GB0212RC	8GB0406VRC	8GB0405VRC	8GB0512
8GB0214RC	8GB0408VRC	8GB0407VRC	

Betagard Residual Current Circuit Breakers 5SM3

Reference No.	Reference No.	Reference No.	Reference No.
5SM33480RC	5SM36480RC	5SM33456RC	5SM36456RC
5SM33450RC	5SM36450RC	5SM34486RC	5SM37456RC
5SM34480RC	5SM37450RC	5SM34456RC	
5SM34450RC	5SM33486RC	5SM36486RC	

Auxiliary contact block for 5SM3 100-125A 4pole 1NO+1NC

Reference No.
5SW3330

Terms and Conditions

Maximum Retail Price (MRP) / List Price (LP) is subject to revision without prior notice.

The company reserves the right to supply goods at its works or godown at its discretion.

The minimum order size for non-stock items (items not marked with ■) is 50 Nos. for each item or ₹ 50,000/- per item.

Export control regulation - retention clause: The fulfillment of the agreement on Siemens part is subject to the provision that this shall not be prevented by implements on the grounds of national and international legal requirements, in particular export control provision.

Stock items

The normal stock items (indicated by ■) are subject to change without prior notice.

Note

- This supercedes all previous Price Lists.
- List Prices (LPs) mentioned are exclusive of all taxes.
- Maximum Retail Prices (MRPs) mentioned in the publication are maximum recommended selling prices.
- Invoice amount not to exceed MRP
- Invoice amount = MRP (less) applicable discount + applicable GST %
- For receiving material in factory sealed packing, we request you to order in multiples of the indicated standard packing quantity.

Ask your nearest Siemens partners to include you in our mailing list.

Always make your purchases only from our authorized dealers. Details available with our sales office/territory managers.



7KT PAC1200

Multichannel current measuring system for flexible multichannel monitoring in final distribution

Current Sensors

- Versions: 40 A, 63 A

Sensor Bar

- Versions available for 3, 6, 9, 12

Data Manager

- Connection of up to 96 sensors (40A/63A)
- DIN rail installation (4MW)

Communication/ Software:

- Modbus TCP/ IP
- Simple system onfiguration via web server
- Easy access to energy data with mobile app (iOS/Android)

*For more details, contact nearest Siemens Sales Office

[siemens.com/powermonitoring](https://www.siemens.com/powermonitoring)

SIEMENS

- Modbus TCP/IP communication
- Simple configuration of system via powerconfig and web server
- Visualization of consumption via Webserver and Mobile App (Android/iOS)

- Flexible sensor bars and current sensors to record up to 96 circuits in one system
- Current sensors simply plug onto the sensor bars, eliminating extensive wiring

fast

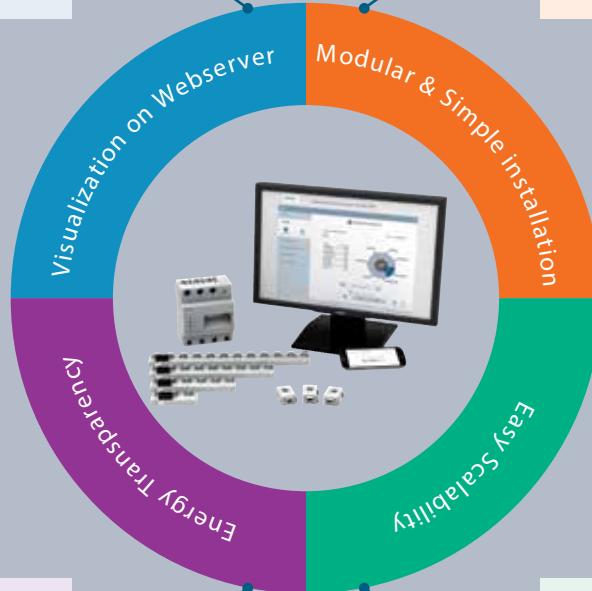

**plug
and
play**

- Targeted detection of power guzzlers
- Simultaneous display of power consumption and costs
- Ensures optimal power monitoring

- Easy to Upgrade
- Scale up the system without any interruption or cumbersome wiring



Easy



Transparent



Cost-efficient



Relevant Standards

Title	IS	IEC	Products							
			MCB		RCCB		RCBO	DB	AFDD	SPD
			5SL4/6/7	5SL5	5SV	5SM	5SU1	8GB	5SM6	5SD7
Electric Installations – MCBs for Building Installations and Similar Purposes Part 1: MCBs for AC Systems	IS 60898-1	IEC 60898-1	✓	–	–	–	–	–	–	–
Low-voltage switchgear and controlgear Part 2: Circuit-breakers	IS 60947-2	IEC 60947-2	–	✓	–	–	–	–	–	–
Residual Current Operated Circuit-Breakers for Household and Similar Uses, Part 1: Circuit-Breakers Without Integral Overcurrent Protection (RCCBs)	IS 12640-1	IEC 61008-1	–	–	✓	✓	–	–	–	–
Residual Current Operated Circuit-Breaking for Household and Similar Uses, Part 2: Circuit-Breakers with Integral Overcurrent Protection (RCBOs)	IS 12640-2	IEC 61009-1	–	–	–	–	✓	–	–	–
General requirements for arc fault detection devices	–	IEC 62606	–	–	–	–	–	–	✓	–
Low-voltage switchgear and controlgear assemblies, Part 2: Power switchgear and controlgear assemblies	–	IEC 61439-1/3	–	–	–	–	–	✓	–	–
Surge protective devices connected to low-voltage power systems	–	IEC 61643-11	–	–	–	–	–	–	–	✓



Degree of Protection

First digit: Protection against solid foreign objects		Second digit: Protection against ingress of water	
	0 No protection		0 No protection
	1 Protected against solid objects up to 50mm (e.g. hand)		1 Protection against vertically falling drops of water (e.g. condensation)
	2 Protected against solid objects up to 12mm diameter (e.g. finger)		2 Protection against direct sprays of water up to 15 degrees from vertical
	3 Protected against solid objects up to 2.5mm diameter (e.g. screwdriver)		3 Protection against direct sprays of water up to 60 degrees from vertical
	4 Protected against solid objects up to 1mm diameter (e.g. wire)		4 Protection against water sprayed from all directions, limited ingress permitted
	5 Protected against dust: limited ingress permitted, no harmful deposit.		5 Protected against low-pressure jets of water from all directions, limited ingress permitted
	6 Totally protected against dust		6 Protected against strong jets of water from all directions, limited ingress permitted (e.g. water from heavy seas on a ship's deck)
			7 Protected against the effect of temporary immersion (30 min) between 15cm and 1m
			8 Protected against long period of immersion under pressure
			9 Protected against high pressure, high temperature jets of water from multiple directions

IP 6 8



Installation Guideline for RCCB

RCCB suitability for various distribution networks.

Betagard RCCBs can be used in all 3 distribution network types viz. TN, TT & an IT network system. 4 pole RCCBs can also be used in 3 pole supply networks by adhering to installation guidelines. In this case, connection must be at terminals 1, 3 and 5 and 2, 4 and 6.

The function of the test equipment is only ensured if a jumper is fitted between terminals 3 and N.

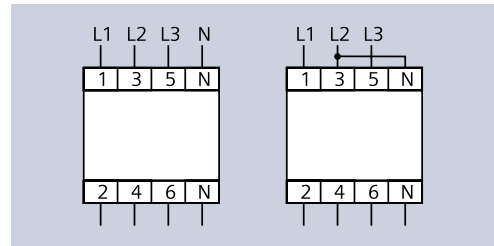

Types and waveform

					6 mA	10 mA		
Type AC		■	-	-	-	-	-	-
Type A		■	■	■	■	-	-	-
Type F		■	■	■	■	■	■	-
Type B		■	■	■	■	■	■	■
Type B+		■	■	■	■	■	■	■

Version

SIGRES	with active condensation protection for use in severe ambient conditions
[G] / [K]	super-resistant, 10 ms short-term delayed devices with increased immunity to false triggering due to transient disruptions
[S]	as an upstream group switch for selective shutdown against downstream RCCBs



Installation locations for Surge Protection Devices (SPDs)

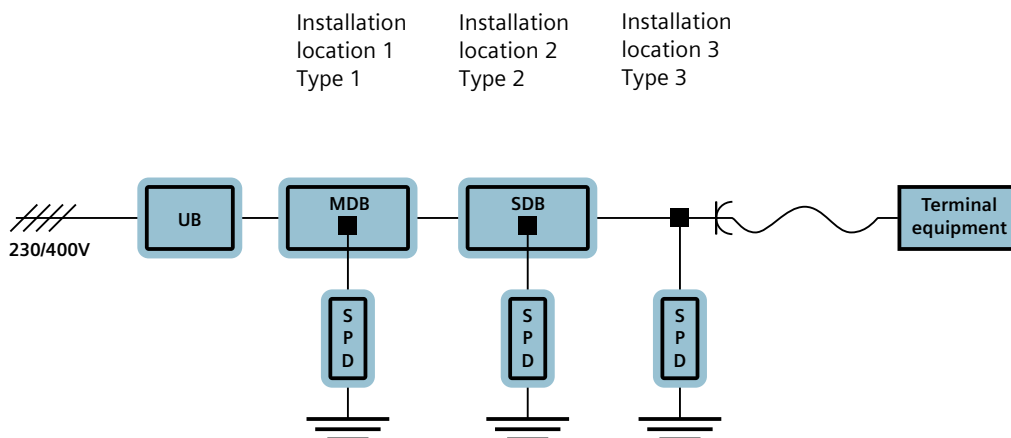

UB: Utility Box

MDB: Main distribution board

SDB: Sub Distribution board

Installation location 1 must be as close as possible to the supply point for the electrical system, so that the downstream installations are protected. The SPDs at installation locations 2 and 3 shall not be used without SPDs at installation location 1, and they must be coordinated with these SPDs (i.e. SPDs all from the same manufacturer).

One point contact for your service needs

The comprehensive range of services from Siemens is sure to cover the needs of the most varied users. We offer structured

services, designed to give you valuable support in every phase during the lifecycle of your Final Distribution Products.

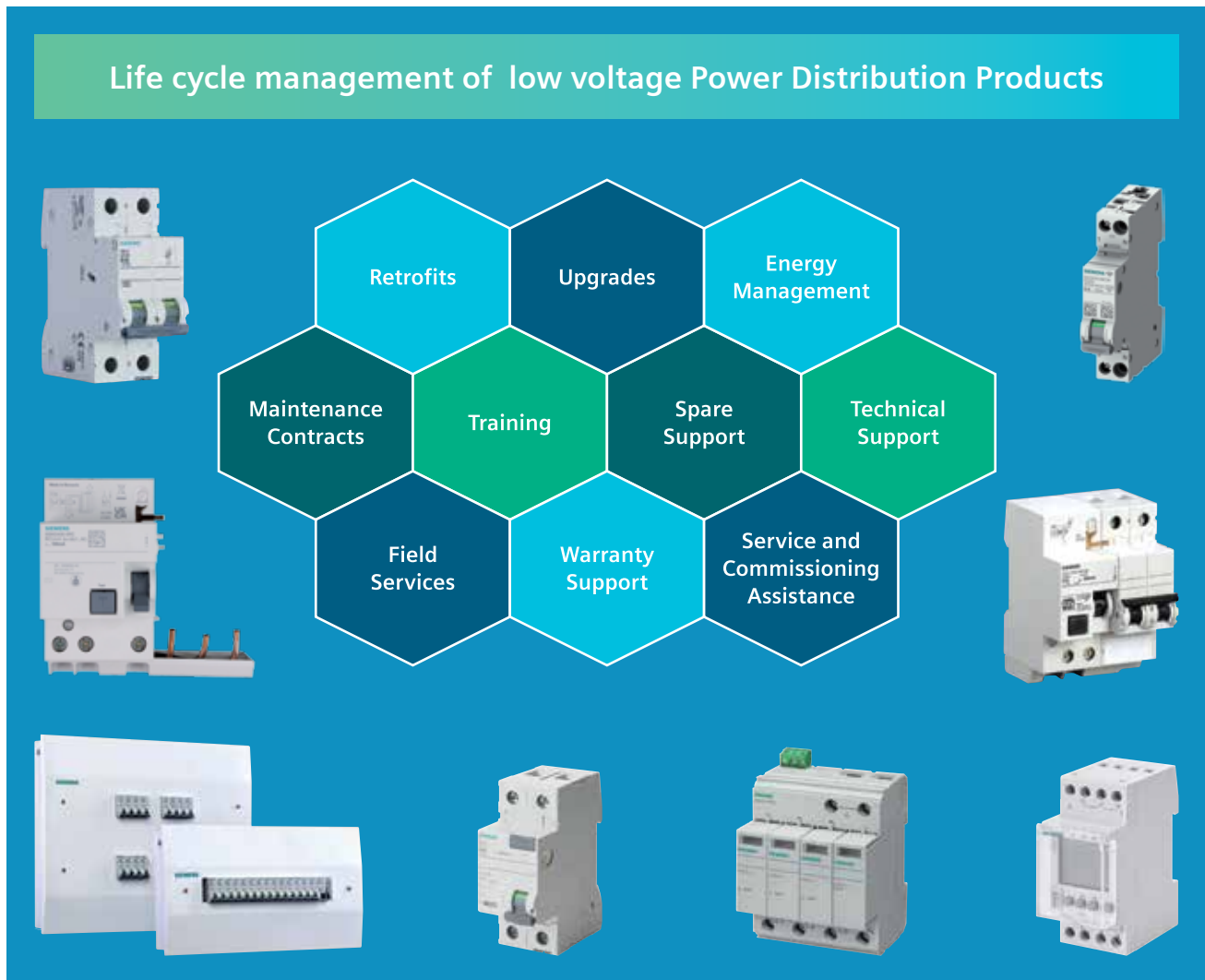

Please contact us for more details

CUSTOMER CARE

Toll Free No: 1800220987 / 18002090987 • E-mail: ics.india@siemens.com

Customer care

One stop support for all service needs:

- Breakdown service
- Annual maintenance contracts
- Retrofit solutions
- Spares
- Digitalization & Panel retrofits

For more details please contact:

Customer care desk

Siemens Limited

R&D Technology Centre

Thane Belapur Road, Airoli Node, Navi Mumbai - 400708

For more information contact toll free 1800 209 1800

Tel.: 022-27600150 • Fax: 022-33265381

<http://support.automation.siemens.com/in>

Notes

A series of horizontal dotted lines for taking notes.

Your partners

Sales offices:

Ahmedabad

3rd Floor, Prerna Arbour, Chimanlal Girdharlal Road
Navrangpura, Near Girish Coldrinks
Ahmedabad, Gujrat - 380009
Tel: +91 79 30927600
Fax: +91 79 30927699
E-mail: chandrakant.keshrani@siemens.com

Baroda

Ground Floor, Urja Bhavan, Maneja Works
Opp. Makarpura Railway Station
Vadodara - 390010
Tel: +91 265 3957701
Fax: +91 265 3039190
E-mail: kalpeshkumar.darji@siemens.com

Bengaluru

1st Floor, Jyoti Mahal
No. 49, St. Marks Road
Bengaluru - 560001
Tel: +91 80 33422000
Fax: +91 80 33424131
E-mail: kumar.cvs@siemens.com

Bhubaneshwar

Mobile: +91 8696222212
E-mail: rohit.nandan@siemens.com

Chandigarh

Mobile: +91 9888484066
E-mail: padam.sharma@siemens.com

Territory managers:

Belgaum

2nd Floor, Sharadha Building, Angol - Vadaganv Road
Belgaum - 590006
Mobile: +91 8105592066
E-mail: siddu.mareguddi@siemens.com

Bharuch

Bungalow No. 1, Sanskar Villa, Behind Yogi Petrol Pump
Narmada Chokdi, Zadeshwar, Bharuch - 392011
Mobile: +91 8884000998
E-mail: viral.kachhadia@siemens.com

Bhopal

B-17, Unique Campus, Near Raja Bhoj Square
Bagsewania, Bhopal - 462043
Mobile: +91 9926415756
E-mail: laxmi-narayan.dhakar@siemens.com

Cochin

E27, Federal Park, Vennala PO, Ernakulam - 682028
Mobile: 9447313241
E-mail: max.tom@siemens.com

Guwahati

Shivalaya Housing Society, Flat No. B-3A
Bylane 4, Joymatinagar, Adabari, Pandu
Guwahati - 781012, Assam
Mobile: +91 9864110684
E-mail: biplab.datta@siemens.com

Haridwar

Asha Niwas, Vill. Kandal, P.O. Koti (KP Kshetra)
Athurwala, Near Jollygrant, Uttarakhand - 248001
Mobile: +91 9808380848
E-mail: rahul.kothari@siemens.com

Indore

Flat No. 404 -B, Elite Anmol Apartment, Udaynagar
Sri Mangal Nagar, Bicholi-Hapsi Road, Indore - 452017
Mobile: +91 8600555694
E-mail: paresh.bhachawat@siemens.com

Jalandhar

H.No. 212A, Punjabi Bagh Extn, Near Curo Mall
Jalandhar - 144001, India
Mobile: +91 9876047929
E-mail: sunil.singla@siemens.com

Jodhpur

17 E 730, Chopasni H.B. Colony
Jodhpur - 342008, Rajasthan
Mobile: +91 8003088889
E-mail: ankur.pancholi@siemens.com

Chennai

4th Floor, ETA Mount Central
Seethakathi Business Centre, Mount Road
Chennai - 600006
Tel: +91 44 30474000
Fax: +91 44 30474080
E-mail: muthu.kumar@siemens.com

Coimbatore

Mobile: +91 9894617776, +91 9894617772
E-mail: sivaprakasam.r@siemens.com
rubengerald.s@siemens.com

Delhi / Gurgaon

Plot No. 78, Tower - B
JagaTjit Industries Building (JIL)
Opposite SBI Academy, Sector-18
Gurgaon - 122015
Tel: +91 124 2842000, 3810200
E-mail: manjeet.mor@siemens.com

Hyderabad

5-9-19, 4th Floor, Lakshmi Narasinh Estate
Hyderabad - 500004
Tel: +91 40 23482578
E-mail: pv.ravikiran@siemens.com

Jaipur

Mobile: +91 9818099433
E-mail: rajesh.raina@siemens.com

Kolhapur

Flat No.1, Swapnapirithi Apartment
Near Head Post office, Ramannala
Kolhapur - 416003
Mobile: +91 91 12633253
E-mail: vijaykumar.patil@siemens.com

Kota

A-1, 1st Floor, Shrinath Estate, Railway Station Road
Kota - 324002, Rajasthan
Mobile: +91 9929110493
E-mail: rajendra.kabra@siemens.com

Ludhiana

H.No. 1235, St. No. 3/1, Sardar Nagar, Rahon Road
Near Gurudwara Mata Bhagwanti
Ludhiana - 141007, India.
Mobile: +91 9872419990
E-mail: ravinder.pal@siemens.com

Nagpur

Plot No. 117, 118, 119, Flat No. 202
Yatharth Apartment, Mahalaxmi Society
Manish Nagar, Nagpur - 440015
Mobile: +91 9049610003
E-mail: sanjay.lonkar@siemens.com

Nashik

103, Aravalli Co-Housing Soc., Near Mahila Bank
Indira Nagar, Nashik - 422009
Mobile: +91 9822193204
E-mail: mayur.kulkarni@siemens.com

Rajpur

Jr. M.I.G 503 Chilpy Height, Bhawna Nagar
Near Shankar Nagar, Raipur - 492007
Mobile: +91 9926511479
E-mail: ravindra.ughade@siemens.com

Rajkot

D-106, City Elite, Near Rukshmani Park
Raiya Road, Rajkot - 360005
Mobile: +91 9033146951
E-mail: shivang.bhatt@siemens.com

Ranchi

Mobile: +91 7033537344
E-mail: soumitra.dutta@siemens.com

Rourkela

U4/8, Civil Town Ship, Near Sailap Hospital
Rourkela - 769004
Mobile: +91 9861056581
E-mail: ashirbad.das@siemens.com

Jamshedpur

Mobile: +91 8294052647
E-mail: shyamal.bhattacharyya@siemens.com

Kolkata

1st Floor, 43, Shanti Palli
Rashbihari Bypass Connector
Kolkata - 700042
Tel: +91 33 30939000
Fax: +91 33 30939010
E-mail: amarnath.karmakar@siemens.com

Lucknow

Mobile: +91 9918002525
Email: atul.shukla@siemens.com

Mumbai

"Business Centre -1
Kalwa Works, Thane Belapur Road
Thane - 400601
Tel: +91 22 39663000
Fax: +91 22 39663721
E-mail: abhijeet.dandekar@siemens.com

Pune

Tower C, Panchshil Business Park
Survey No. 20, Balewadi
Pune - 411045
Tel: +91 20 30466000
Fax: +91 20 30466060
E-mail: kiran.kanhurkar@siemens.com

Rudrapur

Village – Nawar – Khera
Saheed Rajendra Singh Bhakuni Marg
PO - Kathgodam, Golapar
Haldwani - Distt Nainital, Uttrakhand - 263126
Mobile: +91 9839174578
E-mail: girish.pandey@siemens.com

Sonepat

I-4088, First Floor, Ansal Sushant City, Panipat
Mobile: +91 9911316981
E-mail: mohit.bisaria@siemens.com

Sricity

No. 110/21, Kalpaga Nagar, Padianallur
Redhills, Chennai - 600052
Mobile : 8122072921
E-mail: m.karthikeyan@siemens.com

Surat

A1-504, Shradddha Flats, Near Swastik Villa
Pal, Surat - 395009
Mobile: +91 9879110276
E-mail: rahul.gangrade@siemens.com

Trichy

S7, Bharat Citi Squares, Fifth Cross, Ramalinga Nager
First Main Road, Woraiyur, Trichy - 620003, India
Mobile: +91 9840255185
E-mail: r.pradeep@siemens.com

Vapi

803, Dream Icon, Dream City
Vapi Silvassa Road, Dunga Vapi - 396193
E-mail: akif.qadeer@siemens.com
Mobile: +91 987021215

Varanasi

Vrindavan Residency, Nuaon Bypass
Tikari Road, Dafi, Varanasi - 221011 (U.P.)
Mobile: +91 9984500021
E-mail: kumardeepak@siemens.com

Vizag

D No. 18-117/5/27, Flat No. 301, Kavya Nivas
Krishna Nagar, Madurawada
Visakhapatnam - 530048
Mobile: +91 9618046037
E-mail: sivadurgaprasad.mondeti@siemens.com

Siemens Limited
Smart Infrastructure
Electrical Products
R&D Technology Centre
Thane Belapur Road
Airoli Node, Navi Mumbai - 400708
For more information contact toll free 1800 209 1800
E-mail: lvsgr-mktg.india@siemens.com

Order No.: 113886735
SI-EP-CC-DIPL-102023
(This replaces SI-EP-CC-DIPL-092022
dated 15 October, 2022)

Customer Care Toll free no. 1800 209 0987
Email: ics.india@siemens.com

Product upgradation is a continuous process. Hence, data in this pricelist is subject to change without prior notice. For the latest information, please get in touch with our Sales Offices.